

# VX Pro Series

All-in-One Controller

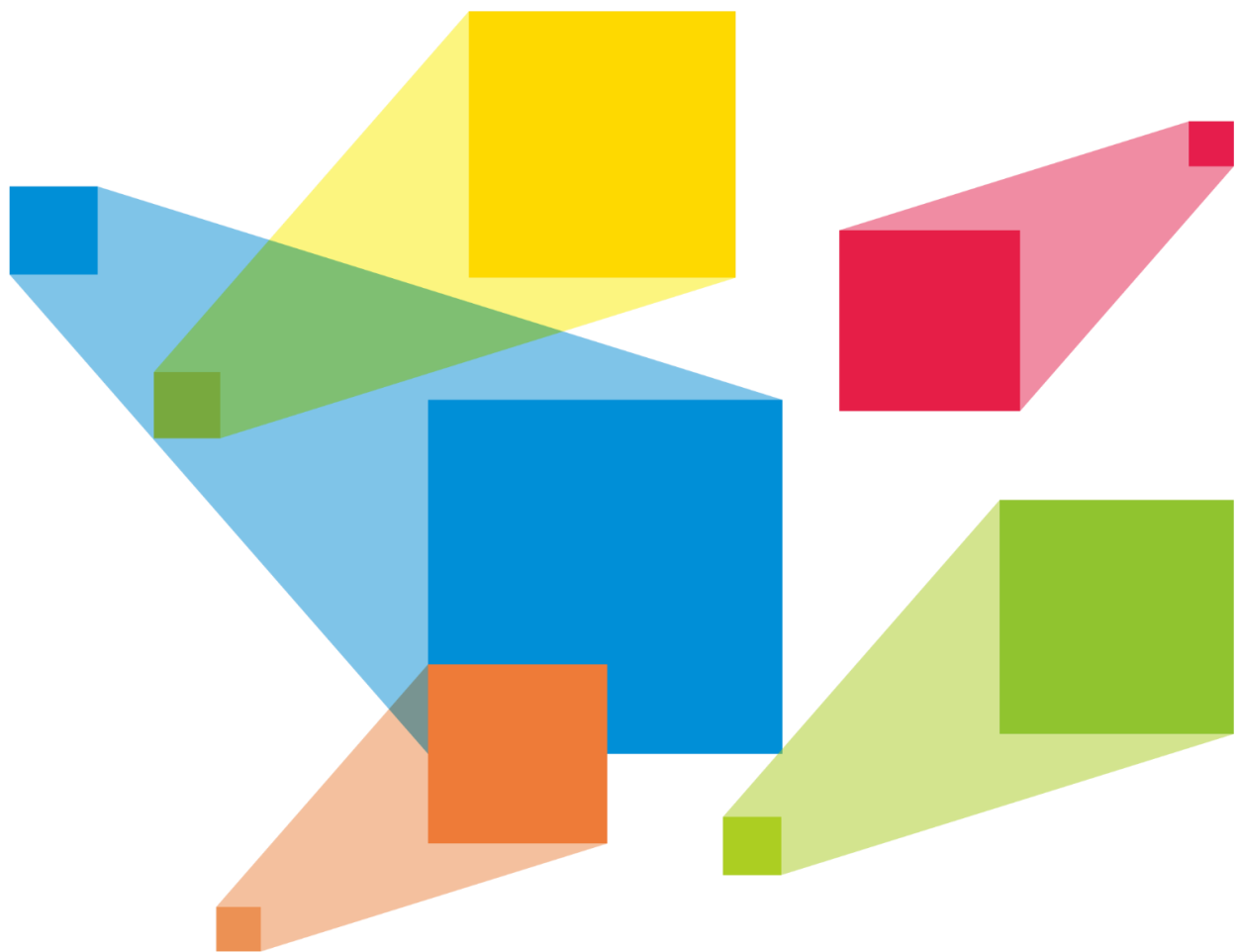

## User Manual

# Contents

---

1 Change History .....	7
2 Applicable Products .....	8
3 Applications.....	9
4 Home Screen .....	10
4.1 Home Screen .....	10
4.2 Second Home Screen .....	12
4.2.1 OPT Status Screen.....	12
4.2.2 Fiber Converter Screen.....	13
5 Menu Operations.....	14
5.1 Screen Brightness.....	14
5.2 Screen Configuration.....	15
5.2.1 Quick Configuration .....	15
5.2.2 Save to RV Card .....	17
5.2.3 Mapping.....	17
5.2.4 LED Screen Color.....	18
5.2.5 Set Output Bit Depth .....	20
5.2.6 Send Cabinet Configuration Files.....	20
5.3 Layer Settings .....	23
5.3.1 Add Layers.....	23
5.3.2 Set Layer Properties.....	25
5.3.3 Input Crop.....	26
5.4 OSD Settings.....	28
5.5 OPT Source Descriptions.....	30
5.6 Input Settings .....	31
5.6.1 Switch Connector Capacity.....	32
5.6.2 Set Input Resolution .....	33
5.6.3 Import and Export EDID.....	35
5.6.4 Compatible with Mac .....	36
5.6.5 Configure InfoFrame Override Parameters.....	37

5.6.6 Configure Mosaic Sources.....	38
5.7 Preset Settings.....	40
5.7.1 Save Presets .....	40
5.7.2 Load Presets.....	41
5.7.3 Delete Presets.....	42
5.8 Image Mosaic.....	43
5.9 Display Control.....	45
5.10 USB Playback.....	46
5.10.1 USB Player .....	47
5.10.2 Playback Settings.....	48
5.11 Advanced Settings .....	50
5.11.1 End-to-End Backup .....	50
5.11.1.1 Device Backup .....	50
5.11.1.1.1 Backup Between Devices .....	50
5.11.1.1.2 Backup Between Ethernet Ports.....	53
5.11.1.2 Input Backup.....	55
5.11.1.3 Ethernet Port Backup Test.....	57
5.11.1.4 Dual RV Cards Backup.....	58
5.11.2 Synchronization.....	59
5.11.3 Audio Settings.....	60
5.11.3.1 Set Audio Status .....	61
5.11.3.2 Select Output Audio .....	62
5.11.3.3 Set Output Volume .....	63
5.11.3.4 Set Input Source Audio .....	63
5.11.4 Low Latency.....	64
5.11.5 HDR.....	66
5.11.5.1 HDR Source Settings.....	66
5.11.5.2 Adjust EOTF.....	67
5.11.6 3D Settings.....	69
5.11.7 Standby Mode.....	70
5.11.8 HDCP Status .....	71
5.11.9 Monitor Settings.....	71
5.12 System Settings.....	72
5.12.1 Fn .....	72

---

5.12.2 Return to Home .....	72
5.12.3 Diagnostics .....	73
5.12.4 Export Logs .....	73
5.12.5 Update Device .....	74
5.12.6 Restore Devices .....	75
5.12.7 Cascading ID .....	76
5.12.8 Remote Control .....	76
5.13 Factory Reset .....	77
5.14 Communication Settings .....	78
5.15 Device Working Mode .....	79
5.16 OPT Mode .....	81
5.17 About Us .....	84
5.18 Language .....	84
6 Remote Control .....	85
6.1 Button Descriptions .....	85
6.2 OSD Menu Descriptions .....	86
7 Software Control .....	91
7.1 Software Installation and Connection .....	91
7.1.1 Software Installation .....	91
7.1.2 Software Connection .....	92
7.2 Project Management .....	92
7.2.1 Create New Projects .....	92
7.2.2 Import Projects .....	94
7.2.3 Export Projects .....	95
7.3 Device Management .....	96
7.3.1 Enter Device Configuration Page .....	96
7.3.1.1 Online Devices .....	96
7.3.1.2 Simulation Devices .....	97
7.3.2 Configure Device Properties .....	99
7.3.2.1 Rename Device .....	99
7.3.2.2 Switch Working Mode .....	100
7.3.2.3 Configure IP Address .....	100
7.3.2.4 Configure Sync Source .....	101

---

7.3.2.5 Configure HDCP .....	102
7.3.2.6 Configure Date and Time .....	103
7.3.2.7 Reset to Factory Settings .....	104
7.3.2.8 Standby Mode .....	105
7.3.2.9 Restart Device .....	106
7.3.2.10 Configure Input Source Backup .....	106
7.3.3 Configure Input Properties .....	108
7.3.3.1 View Input Source Info .....	108
7.3.3.2 View OPT Source Info .....	109
7.3.3.3 Set Input Connector Capacity .....	110
7.3.3.4 Configure Input HDCP .....	111
7.3.3.5 Configure InfoFrame Override Parameters .....	112
7.3.3.6 Set HDR .....	113
7.3.3.7 Configure EDID .....	114
7.3.3.8 Configure Compatibility with Mac .....	116
7.3.3.9 Import and Export EDID .....	117
7.3.4 Configure Output Properties .....	118
7.3.4.1 Set OPT Ports .....	118
7.3.4.2 Set Monitoring .....	120
7.4 Screen Configuration .....	121
7.4.1 Configure Sub-Screens .....	121
7.4.1.1 Add Sub-Screens .....	121
7.4.1.2 Set Sub-Screens .....	122
7.4.2 Configure Screen Topology .....	124
7.4.2.1 Configure Online Cabinets .....	124
7.4.2.2 Configure Empty Cabinets .....	129
7.4.3 Configure Screen Properties .....	132
7.4.3.1 Rename Screens .....	133
7.4.3.2 Configure Low Latency .....	133
7.4.3.3 Set Canvas Size .....	135
7.4.3.4 Configure Test Patterns .....	136
7.4.3.5 Configure Output Color .....	138
7.4.4 Configure Cabinet Properties .....	139
7.4.4.1 View Cabinet Library .....	139

---

7.4.4.2 Change Cabinet Resolutions.....	140
7.4.4.3 View Cabinet Info.....	141
7.4.4.4 Configure Cabinet Groups.....	142
7.4.4.5 Configure Cabinet Positions .....	142
7.4.4.6 Set Cabinets.....	143
7.4.4.7 Configure Ethernet Port Backup.....	145
7.4.4.8 Set Dual RV Cards Backup.....	146
7.5 Screen Correction .....	147
7.5.1 Correct Seams.....	147
7.5.2 Erase Seam Correction .....	150
7.6 Screen Settings.....	151
7.6.1 Adjust Image Quality.....	151
7.6.1.1 Adjust Brightness and Gamma.....	151
7.6.1.2 Set LED Image Booster .....	152
7.6.1.3 Adjust EOTF .....	153
7.6.2 Adjust Output .....	155
7.6.2.1 Set Output Bit Depth.....	155
7.6.2.2 Configure 3D .....	155
7.6.2.3 Check Load.....	157
7.7 Layer Operations.....	158
7.7.1 Add Layers.....	158
7.7.2 Configure Video Source Properties .....	159
7.7.3 Mosaic Source Settings.....	160
7.7.3.1 View Mosaic Source Info .....	160
7.7.3.2 Configure Mosaic Sources .....	161
7.7.4 Configure USB Source Properties .....	162
7.7.4.1 Play USB Files.....	162
7.7.4.2 Configure Playback Parameters .....	163
7.7.5 Set Audio .....	165
7.7.6 Set Input Source Audio .....	167
7.7.7 Configure Layer Properties.....	168
7.7.7.1 Configure Basic Properties.....	168
7.7.7.2 Crop Layer Sources.....	170

---

7.7.8 Configure OSD.....	171
7.7.8.1 Configure Text OSD .....	172
7.7.8.2 Configure Image OSD.....	184
7.7.9 Manage Presets.....	186
7.8 Tools.....	189
7.8.1 Maintenance.....	189
7.8.1.1 Maintain Devices .....	189
7.8.1.2 Maintain Cabinets.....	192
7.8.2 Configure Device Backup .....	193
7.8.3 Manage Cabinet Library .....	195
7.8.4 Device Discovery.....	198
7.8.5 Test Tool .....	199
7.9 Software Settings.....	200
7.9.1 Switch UI Language.....	200
7.9.2 Change Skin.....	200
7.9.3 Export Logs .....	201
7.9.4 Configure Preferences .....	201
7.9.5 View Software Info.....	201
7.9.6 Check User Manual .....	201
8 Appendix.....	202
8.1 Loading Capacity Calculation Method in Low Latency Mode.....	202
9 Copyright .....	204

# 1 Change History

Document Version	Release Date	Description
V1.3.0	2026-02-28	<ul style="list-style-type: none"> <li>• Added the description for importing and exporting cabinet files.</li> <li>• Added the description for restoring the device.</li> <li>• Added the description for automatically enabling the low latency function.</li> <li>• Added the description for adding sub-screens.</li> <li>• Added the description for screen correction.</li> <li>• Added the description for setting the preset switching effect.</li> <li>• Added the description for image mosaic.</li> </ul>
V1.2.0	2025-09-30	<ul style="list-style-type: none"> <li>• Added the description for the device standby mode.</li> <li>• Added the description for the options of the monitoring image definition, include smooth and high-definition.</li> <li>• Added the description for the dual receiving card backup.</li> <li>• Added the description for screen power-on and power-off through a remote control.</li> <li>• Added the description for the function of compatible with Mac.</li> <li>• Added the description for the Unico client software.</li> </ul>
V1.1.1	2025-08-15	<ul style="list-style-type: none"> <li>• Added the description for the OSD function.</li> <li>• Added the description for the remote control.</li> <li>• Added the description for the HDR function.</li> <li>• Updated the Unico web page operations.</li> </ul>
V1.1.0	2025-01-06	Added the descriptions of the VX400 Pro, VX600 Pro and VX1000 Pro.
V1.0.1	2024-12-16	Update Unico-related information.
V1.0.0	2024-12-10	First release

## 2 Applicable Products

The content described in the user manual is applicable for the following products:

VX400 Pro, VX600 Pro, VX1000 Pro and VX2000 Pro

# 3 Applications

The application diagram takes the VX2000 Pro as an example.

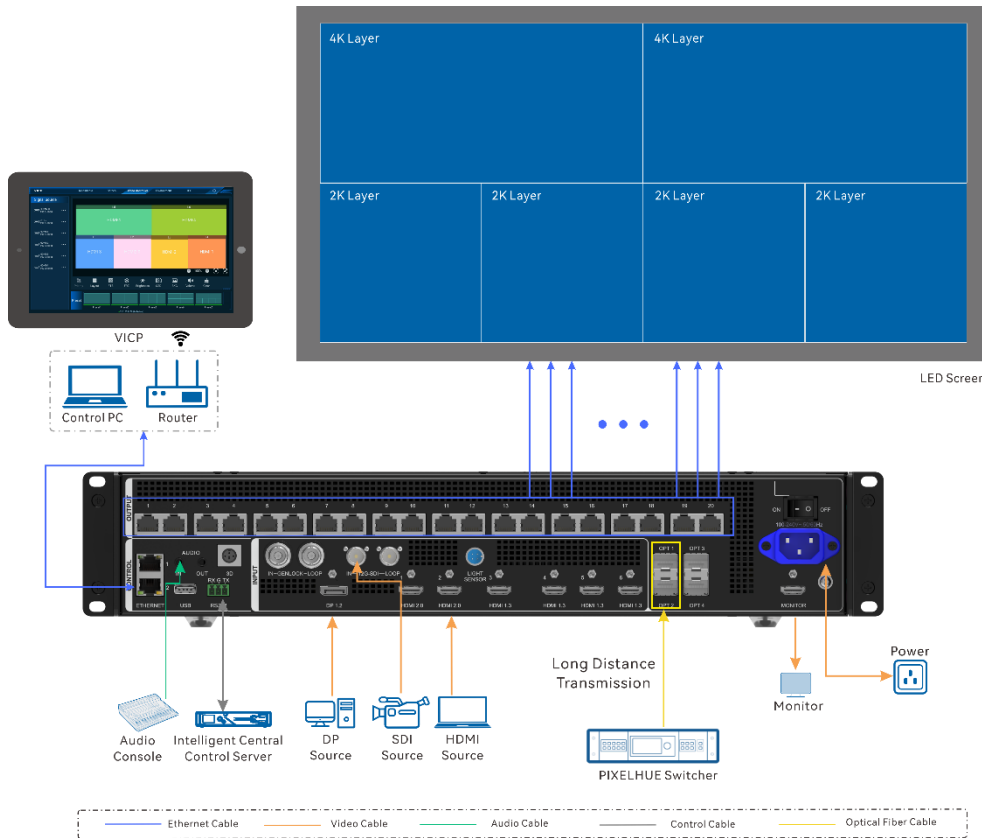

# 4 Home Screen

















This chapter takes the VX2000 Pro as an example.

## 4.1 Home Screen

Figure 4-1 Home Screen



No.	Content	Description
1	VX2000 Pro	The device name
		<ul style="list-style-type: none"> <li>Hold down the knob and BACK button simultaneously to lock or unlock the front panel buttons.</li> <li>After the buttons are locked, all the button operations will not take effect and the  icon will appear.</li> <li>After the buttons are unlocked, the  icon will disappear.</li> </ul>
	192.168.0.10	The device IP address
2	<ul style="list-style-type: none"> <li>Layer 1</li> <li>Layer 2</li> <li>Layer 3</li> </ul>	Displays the opened layer information, including the layer number, input source, input resolution and frame rate
3	1920×1080@60	Displays the resolution and frame rate of the configured screen.
	100%	The screen brightness

No.	Content		Description
4			The Ethernet port is connected.
			The Ethernet port is not connected.
			<ul style="list-style-type: none"> <li>The Ethernet port is connected and serves as the backup output port.</li> <li>When the backup icon at the bottom flashes, there is data transmission on the port.</li> </ul>
5	Synchronization		The sync function is enabled and the synchronization succeeded.
			The sync function is not enabled.
			The sync function is enabled and the synchronization is in progress.
			The sync function is enabled but the synchronization failed.
	Display control		The output is black.
			The test pattern is shown.
			The output image is displayed.
			The output image is frozen.
	Connection method		The device is connected to the control PC via an Ethernet port.
			The device is not connected to the control PC.
			The device is connected to the control PC via a USB cable.
	USB insertion status		USB drive inserted.
			No USB drive inserted.

## 4.2 Second Home Screen

### 4.2.1 OPT Status Screen

When the device is in **Video Controller** mode, this page may vary according to the device connected to the OPT port, as well as the OPT 3/4 working mode and the OPT loop mode.

- When a fiber converter is connected to OPT 1/OPT 2, the port is used as an output connector. The OPT status page displays the connection and backup statuses of the Ethernet ports on the fiber converter connected to the VX2000 Pro, as shown in [Figure 4-2](#).

Figure 4-2 OPT Status screen



- When a PIXELHUE video processor is connected to OPT 1/OPT 2, the port is used as an input connector. The OPT status page displays the resolution and frame rate of the accessed OPT source and the connection and backup statuses of the Ethernet ports on the fiber converter connected to the VX2000 Pro, as shown in [Figure 4-3](#).

Figure 4-3 OPT input



- When OPT loop mode is enabled, the OPT status page is shown as follows.

Figure 4-4 OPT Loop

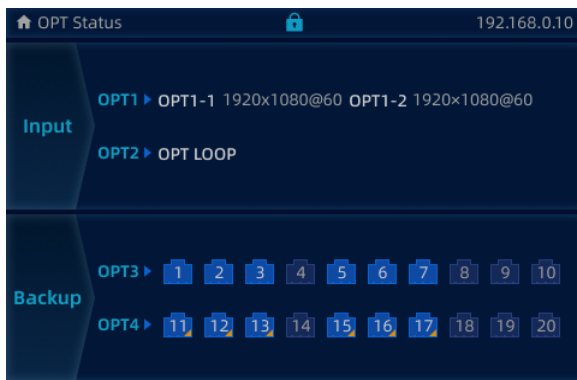

**Note**



You can set the working mode of OPT 3 and OPT 4 to **Copy** or **Backup**. The OPT status screen page will display the set working mode.

## 4.2.2 Fiber Converter Screen

When the device working mode is set to **Fiber Converter**, OPT 1~4 are all used for input and Ethernet ports are used for output. OPT 1 and OPT 2 serve as the primary connectors, while OPT 3 and OPT 4 serve as backup ones. The fiber converter screen page displays the data transmission status of Ethernet ports on the fiber converter.

Figure 4-5 Fiber converter screen



- : There is data transmission on Ethernet port.
- : No data transmission on Ethernet ports

# 5 Menu Operations

 Note

Knob:

- On the home screen, press the knob to enter the operation menu screen.
- On the operation menu screen, rotate the knob to select a menu item and press the knob to confirm the selection or enter the submenu.
- When a menu item with parameters is selected, you can rotate the knob to adjust the parameters. Please note that after the adjustment, you need to press the knob again to confirm the adjustment.

**BACK:** Exit the current menu or cancel an operation.

## 5.1 Screen Brightness

Screen brightness allows you to adjust the LED screen brightness in an eye-friendly way according to the current ambient illuminance. Besides, the brightness parameters can be saved to the receiving cards.

### Prerequisites

The device is connected to a screen.

### Screen Example

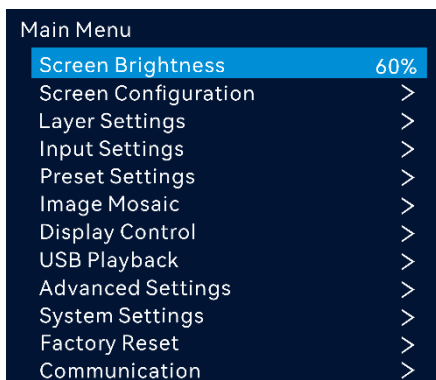

## Operating Procedure

- Step 1 On the home screen, press the knob to enter the main menu screen.
- Step 2 Select **Screen Brightness** and press the knob to confirm the selection.
- Step 3 Rotate the knob to adjust the brightness value. You can see the adjustment result on the LED screen in real time. Press the knob to apply the brightness you set when you are satisfied with it.

## 5.2 Screen Configuration

Screen configuration allows you to perform the following operations, including configuring the screen, saving configuration to the receiving card, setting output mapping, setting the LED screen color and setting the output bit depth.

Figure 5-1 Screen configuration

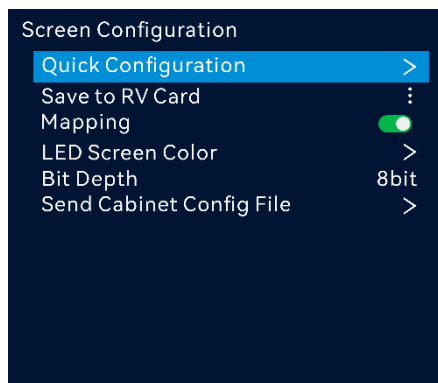

### 5.2.1 Quick Configuration

When the LED screen is a regular one composed of cabinets from the same batch, you can use the quick configuration function to configure the LED screen.

#### Prerequisites

- The LED screen must be a regular one.
- The cabinets of the screen must be regular cabinets with the same resolution.
- The following data flow settings are supported. During data flow settings, ensure that each port's physical connection is along the same direction and downward to the next one.

- During data flow settings, ensure that Ethernet Port 1 is at the beginning of the actual physical connection.

Figure 5-2 Data flow



## Notes

- Cabinets loaded by Ethernet port 1  $\geq$  cabinets loaded by Ethernet port 2  $\geq$  ...  $\geq$  cabinets loaded by Ethernet port n ("n" represents the maximum port number.)
- The number of cabinets loaded by each Ethernet port must be an integer multiple of **Cabinet Row Qty** or **Cabinet Column Qty** of the screen.
- The total pixels of the cabinets loaded by Ethernet port 1 cannot exceed 650,000.

## Screen Example

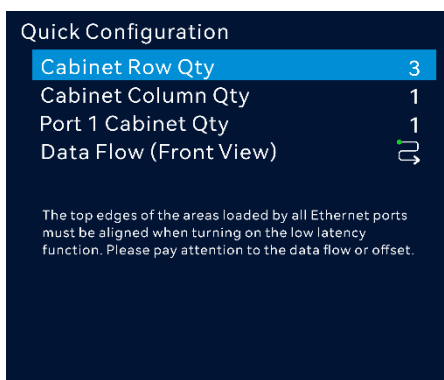

## Operating Procedure

- Step 1 On the main menu screen, rotate the knob to go to **Screen Configuration > Quick Configuration** to enter the quick configuration screen.
- Step 2 Set **Cabinet Row Qty** and **Cabinet Column Qty** according to the cabinets' actual row and column quantities.
- Step 3 Rotate the knob to select **Port 1 Cabinet Qty** to set the quantity of the cabinets loaded by Ethernet port 1.
- Step 4 Rotate the knob to select **Data Flow (Front View)** and press the knob to confirm. Select a physical connection for the cabinets.

During data flow settings, you can see the result on the LED screen in real-time. If the entire screen displays content correctly, that is, no overlapping or repetition, press the knob to save the settings.

## 5.2.2 Save to RV Card

After the screen configuration information is sent to the receiving card, you can save the configuration to the card by using this function so that the configuration data will not be lost after a power failure.

### Screen Example

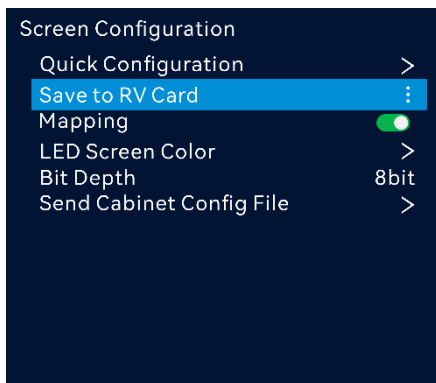

### Operating Procedure

On the main menu screen, go to **Screen Configuration > Save to RV Card** and press the knob to confirm.

## 5.2.3 Mapping

Mapping is used to show the relations between the cabinets of the LED screen and the sending devices so that you can view or check the connections between the cabinets.

### Notes

The receiving cards that are connected to the device must support the Mapping function. For the supported models of the receiving cards, please visit our official website at

## Screen Example

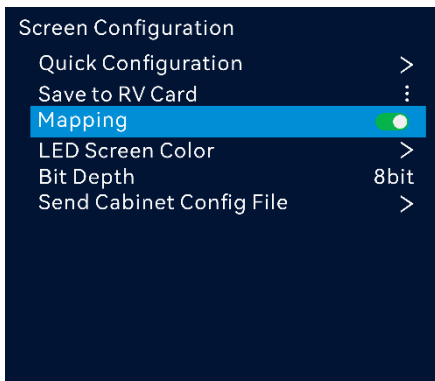

## Operating Procedure

On the main menu screen, go to **Screen Configuration > Mapping** and turn on the function.

Figure 5-3 Mapping



Example: **S:01** stands for the sending card number, **P:01** stands for the Ethernet port number and **#001** stands for the cabinet number.

### 5.2.4 LED Screen Color

This function allows you to adjust the color temperature and Gamma value of the LED screen to make the images displayed on the screen more clear and vivid.

## Screen Example

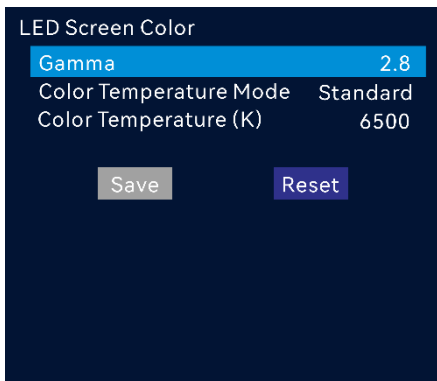

## Operating Procedure

On the main menu screen, go to **Screen Configuration > LED Screen Color** to enter the screen color settings screen.

- Select **Gamma** and press the knob to confirm. Rotate the knob to adjust the Gamma value and press the knob to confirm when you are satisfied with it.
- Rotate the knob to select **Color Temperature Mode** and press the knob to confirm. Rotate the knob to adjust the temperature mode, including **Standard, Cool, Warm** and **Custom**, and then press the knob to confirm when you are satisfied with it.

When **Custom** is selected, you can customize the color temperature value.

- Perform the following operations as needed.
  - Save: Save the LED screen color parameters to the receiving card, so that the parameters will be not be lost after power failure.
  - Reset: Reset all parameters to factory defaults.

## Parameter Descriptions

Parameter	Description
Gamma	Adjust the image distortion degree from the input to output. The greater the value is, the more distorted the image will be.  The value ranges from 0.25 to 4.00 and defaults to 2.8.
Color Temperature Mode	Adjust the cool or warm degree of images displayed on the LED screen. When <b>Custom</b> is selected, you can customize the color temperature value.

## 5.2.5 Set Output Bit Depth

### Notes

When you use the HDR function, setting output bit depth to 10bit is required to achieve optimal display effect.

### Screen Example

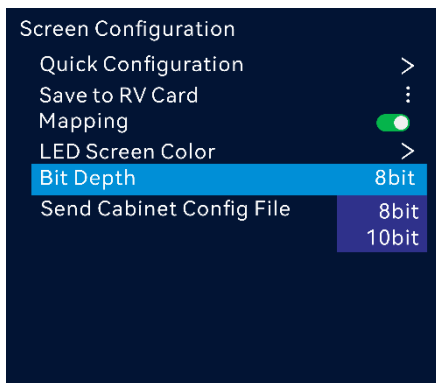

### Parameter Descriptions

Parameter	Description
Bit Depth	Set the output bit depth. The supported options include <b>8bit</b> and <b>10bit</b> .

## 5.2.6 Send Cabinet Configuration Files

You can send the pre-stored configuration file to the receiving card to unify display effect on all cabinets with no need to perform operations on the control PC, realizing convenient debugging. The cabinet file can be exported and imported to other devices, facilitating multi-device control and on-site maintenance.

### Prerequisites

- Before importing the cabinet file, you have placed the .rcfgx or .NCP file in the root directory of the USB drive, and inserted the USB drive in to the USB 2.0 port on the device rear panel.

- Before exporting the cabinet file, you have inserted the USB drive in to the USB 2.0 port on the device rear panel.

## Notes

- 64 configuration files can be saved, with a total capacity less than 500 MB.
- It is recommended that the size and shape of the cabinets to be configured are the same, as well as use the receiving cards of the same model.

## Screen Example

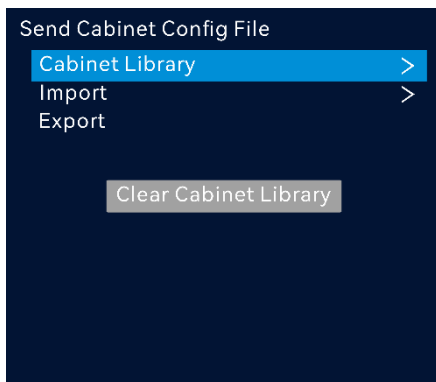

## Import Cabinet Configuration Files

You can import the cabinet file to the device cabinet library via the following methods.

- Method I: Import the file via Unico.
- Method II: Import the file via USB drive.

**Step 1** On the **Send Cabinet Config File** screen, rotate the knob to select **Import** and press the knob to confirm.

**Step 2** Rotate the knob to select the desired file and press the knob to confirm. In the popup dialog box, select **Export** or **Export All**.

## Send Cabinet Configuration Files

You can send the cabinet file to the receiving card via the following methods.

- Method I: Send the file via USB drive.

On the **Import** screen, rotate the knob to select the desired file and press the knob to confirm. In the popup dialog box, select **Send** to send the selected file to the receiving card. This file will not be imported to the cabinet library.

- Method II: Select the desired file in the cabinet library and send it.

**Step 1** On the **Send Cabinet Config File** screen, rotate the knob to select **Cabinet Library** and press the knob to confirm.

**Step 2** Rotate the file to select the file and press the knob to confirm.

**Step 3** In the popup dialog box, select **Send** and press the knob to confirm.

**Step 4** In the popup dialog box, select **OK** and wait for sending.

## Export Cabinet Configuration Files

On the **Send Cabinet Config File** screen, rotate the knob to select **Export**. In the popup dialog box, select **OK** to export all cabinet files in the cabinet library to the inserted USB drive.

## Delete Files in Cabinet Library

You can delete the file in the cabinet library via the following methods.

- Method I: Delete a single file.

**Step 1** On the **Send Cabinet Config File** screen, rotate the knob to select **Cabinet Library** and press the knob to confirm.

**Step 2** On the **Cabinet Library**, rotate the knob to select the desired file and press the knob to confirm. In the popup dialog box, select **Delete** to delete the selected file.

- Method II: Clear all files in the cabinet library.

On the **Send Cabinet Config File**, rotate the knob to select **Clear Cabinet Library** and press the knob to confirm. In the popup dialog box, select **OK**.

## 5.3 Layer Settings

### 5.3.1 Add Layers

#### Notes

The maximum number of layers that can be added depends on the connected device.

Device Model	Number of Supported Layers (2K×1K)
VX400 Pro	6
VX600 Pro	
VX1000 Pro	
VX2000 Pro	12

#### Screen Example

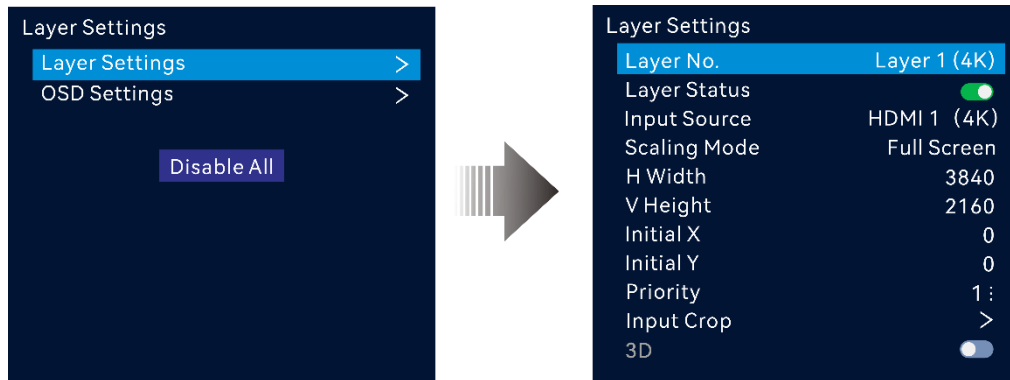

#### Operating Procedure

- Step 1 On the home screen, press the knob to enter the main menu screen.
- Step 2 Rotate the knob to select **Layer Settings** and press the knob to enter the layer settings screen.
- Step 3 Rotate the knob to select **Layer Settings** and press the knob to enter the layer properties screen.
- Step 4 Rotate the knob to select **Layer No.** and press the knob to display the layer list.

 Note

- In the layer list, both the current opened layers and the layers to be opened are displayed.
- Layer name displayed in the layer list: Opened layer: Layer n (capacity), unopened layer: Layer n, and “n” represents the layer number.

- Step 5** Rotate the knob to select the desired layer number and press the knob to confirm.
- Step 6** Rotate the knob to select **Layer Status** and press the knob to turn on the switch.
- Step 7** Rotate the knob to select **Input Source** and select the desired input source for the layer.
- Step 8** Rotate the knob to select other layer parameters and set them if needed. The layer parameter descriptions are shown in [Set Layer Properties](#).

Figure 5-5 Layer parameter descriptions

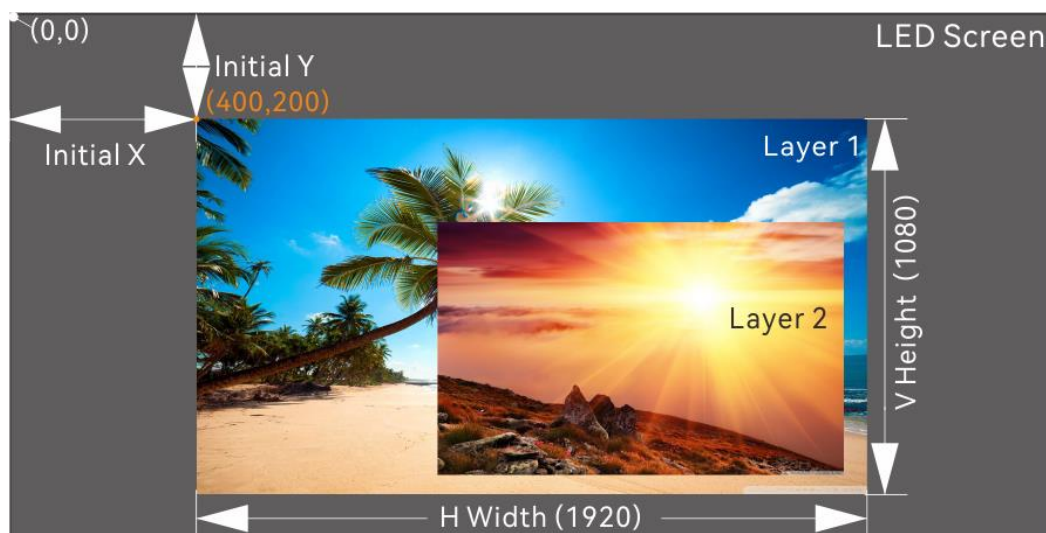

- Step 9** Rotate the knob to select **Priority** and set the layer priority.

The greater the priority number is, the higher priority the layer has.



 Note



On the **Layer Settings** screen, rotate the knob to select **Disable All** and press the knob to disable all layers.

## 5.3.2 Set Layer Properties

### Parameter Descriptions

Table 5-1 Layer properties

Menu	Description
Layer No.	The layer number
Layer Status	<p>Open or close the layer</p> <p> Note</p> <p>By default, layer 1 is opened and uses the first input source.</p>
Input Source	<p>Select an input source for the current layer.</p> <p> Note</p> <p>Press an input source button in the <b>SOURCE</b> area on the device front panel to quickly select an input source for the layer.</p>
Scaling Mode	<p>The layer supports the following three scaling modes.</p> <ul style="list-style-type: none"> <li>• Full Screen: The layer image fills the whole screen.</li> <li>• Pixel to Pixel: The layer image is not scaled but displayed in the original size of the input source or the cropped source.</li> <li>• Custom: Customize the layer size and the output image is scaled according to the layer size.</li> </ul>
H Width	<p>Set the layer size in the horizontal direction.</p> <p>The width value ranges from 64 to 131070.</p>
V Height	<p>Set the layer size in the vertical direction.</p> <p>The height value ranges from 64 to 131070.</p>
Initial X	<p>Set the horizontal distance between the top left corner of the layer and the top left corner of the screen.</p> <p>The value ranges from -250000 to 248080.</p>
Initial Y	<p>Set the vertical distance between the top left corner of the layer and the top left corner of the screen.</p> <p>The value ranges from -250000 to 248080.</p>
Priority	<p>The layer priority</p> <ul style="list-style-type: none"> <li>• Up: Bring the selected layer forward.</li> <li>• Down: Send the selected layer backward.</li> </ul>

Menu	Description
	<ul style="list-style-type: none"> <li>• Top: Bring the selected layer to the front.</li> <li>• Bottom: Send the selected layer to the back.</li> </ul>
Input Crop	<p>Crop the input source image and display the cropped part on full screen.</p> <ul style="list-style-type: none"> <li>• Status: Turn on or turn off the function.</li> <li>• H Width: The size of the copped part in the horizontal direction</li> <li>• V Height: The size of the copped part in the vertical direction.</li> <li>• Initial X: Set the start position for the cropping in the horizontal direction. The value defaults to 0.</li> <li>• Initial Y: Set the start position for the cropping in the vertical direction. The value defaults to 0.</li> </ul>
3D	<p>Turn on or turn off the function.</p> <ul style="list-style-type: none"> <li>• On: </li> <li>• Off: </li> </ul>

### 5.3.3 Input Crop

This function allows you to crop the input source image and make the cropped part display on full screen.

#### Prerequisites

A fine signal is connected to the input connector.

#### Notes

- The status and capacity of the cropped source remain consistent with the original one.
- The input cropping and 3D functions cannot be enabled at the same time.

## Screen Example

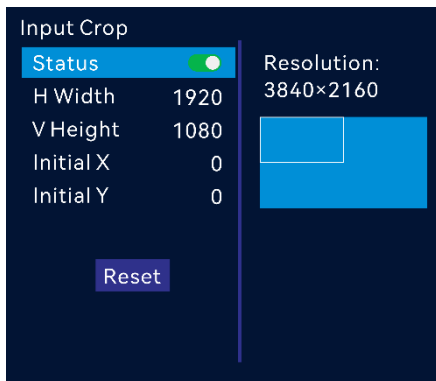

## Operating Procedure

- Step 1 On the **Layer Settings** screen, rotate the knob to select **Input Source** and press the knob to display the input source list.
- Step 2 Rotate the knob to select the desired input source and press the knob to confirm.
- Step 3 Rotate the knob to select **Input Crop** and press the knob to enter the input source cropping screen.
- Step 4 Select **Status** and press the knob to turn on the function.
- Step 5 Rotate the knob to configure the cropping parameters and set them if needed. The cropping parameter descriptions are shown in [Set Layer Properties](#) and [Figure 5-5](#).

Figure 5-6 Input crop effect

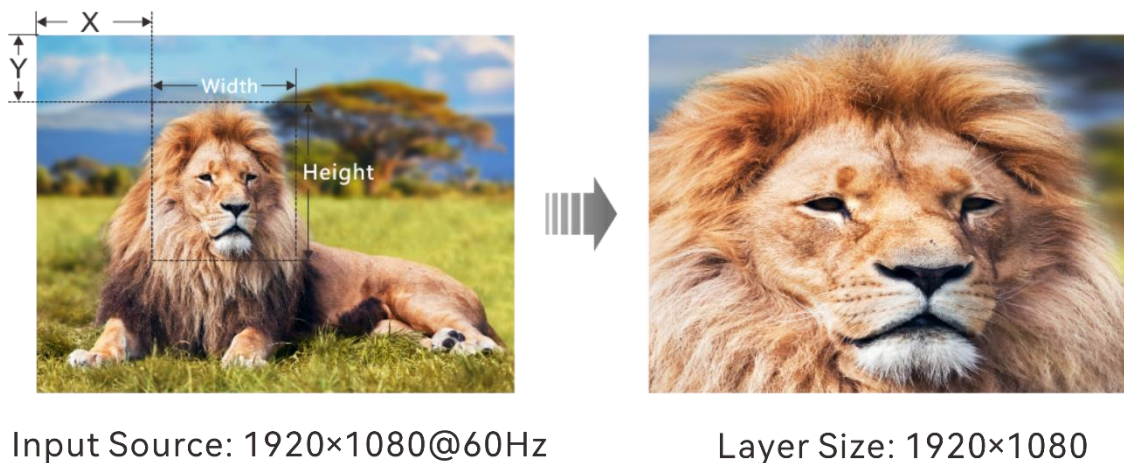

Input Source: 1920×1080@60Hz

Layer Size: 1920×1080

## 5.4 OSD Settings

Both the text OSD and image OSD are supported. For the text OSD, four components are supported, including the static text OSD, dynamic text OSD, weather OSD and time OSD.

### Prerequisites

- Before sending a text OSD to an LED screen via device, make sure that you have configured a text OSD preset in Unico.
- Before sending an image OSD to an LED screen via device, make sure that you have imported images in Unico, or imported images saved in a USB drive which is installed into the USB port on the device rear panel.

### Notes

- The related parameters of a text OSD cannot be set via device LCD screen, and you need to set them in Unico in advance.
- Scaling and cropping an image OSD is not supported via device LCD screen, and you need to set the scaling ratio and cropped image after you have imported images in Unico.
- The OSD locates at the top and its priority cannot be adjusted.
- The text OSD and image OSD cannot be enabled together.
- The OSD function and remote control function cannot be enabled together.

### Screen Example

Figure 5-7 Text OSDs

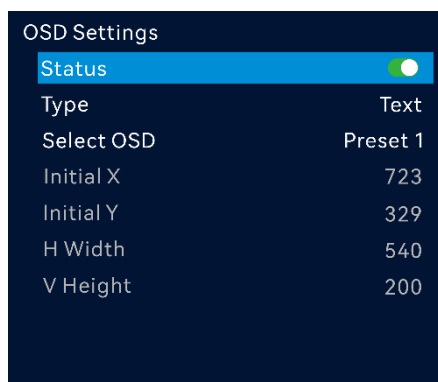
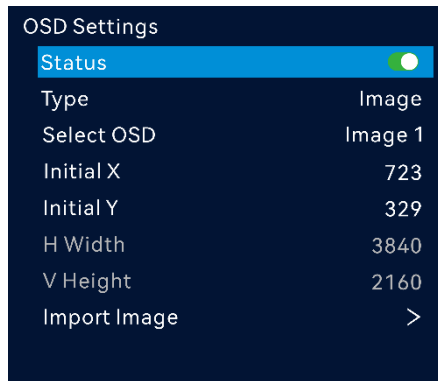

Figure 5-8 Image OSDs



## Operating Procedure

- Step 1** On the **Layer Settings** screen, rotate the knob to select **OSD Settings** and press the knob to enter the OSD settings screen.
- Step 2** Rotate the knob to select **Status** and press the knob to turn on the switch to enable the OSD function.
- Step 3** Set the OSD type. The supported options include **Text** and **Image**.
- Text: You have configured a text OSD preset in Unico.
  - Image: You have imported images in Unico or imported images saved in a USB drive.
- Step 4** (Optional) Rotate the knob to set the initial X and initial Y of an image OSD, and press the knob to confirm.

### Note

If the configured OSD parameters are changed, you need to click **Apply** in Unico to resend the OSD parameters.

## OSD Type Descriptions

OSD Type	Description
Text OSD	<ul style="list-style-type: none"> <li>• Up to four text OSD presets are supported, and the preset 1 is selected by default. The quantity of the text components are as follows. <ul style="list-style-type: none"> <li>– Static text OSD: 10</li> <li>– Weather OSD: 2</li> <li>– Time OSD: 2</li> <li>– Dynamic text OSD: 1</li> </ul> </li> </ul>

OSD Type	Description
	<ul style="list-style-type: none"> <li>Does not support settings of the size and position of a text OSD.</li> </ul> <p> Note</p> <p>The dynamic text OSD and other text components cannot be used together.</p>
Image OSD	<ul style="list-style-type: none"> <li>Image gallery capacity: 75 MB</li> <li>Supported image OSD formats: PNG/JPG/JPEG/BMP</li> <li>Width and height limitations of a single image:                             <ul style="list-style-type: none"> <li>VX400 Pro/VX600 Pro/VX1000 Pro: Max width × Max height ≤ 4096×1080, max width: 10240 pixels, max height: 8192 pixels</li> <li>VX2000 Pro: Max width × Max height ≤ 4096×2160, max width: 16384 pixels, max height: 8192</li> </ul> <p>Note: If the max width and height limitations are exceeded, you need to scale or crop the image in Unico, and the width and height of the cropped should be greater than 64 pixels.</p> </li> <li>Supports setting of the image OSD position.</li> <li>Does not support setting of the image OSD size.</li> <li>Does not support setting of the image OSD opacity.</li> </ul>

## 5.5 OPT Source Descriptions

The device can receive long-distance video sources via OPT ports.

- The OPT source can be provide via a switcher or fiber extender.
- OPT 1 and OPT 2 match the silkscreens marked on the device rear panel. If two SL sources are received via OPT 1, both OPT 1-1 and OPT 1-2 have an input source respectively; if a DL source is received via OPT 1, only OPT 1-1 has an input source.

The relationship between the OPT source and OPT port is as follows.

Table 5-2 OPT source description

Product Model	Description
VX400 Pro	Self-adaptive OPT 1 for video input
VX600 Pro	You can select OPT 1-1 or OPT 1-2 source from the input source list displayed on the device LCD screen.
VX1000 Pro	
VX2000 Pro	Self-adaptive OPT 1/OPT 2 for video input You can select OPT 1-1, OPT 1-2, OPT 2-1 or OPT 2-2 source from the input source list displayed on

Product Model	Description
	the device LCD screen.

Figure 5-9 OPT input sources

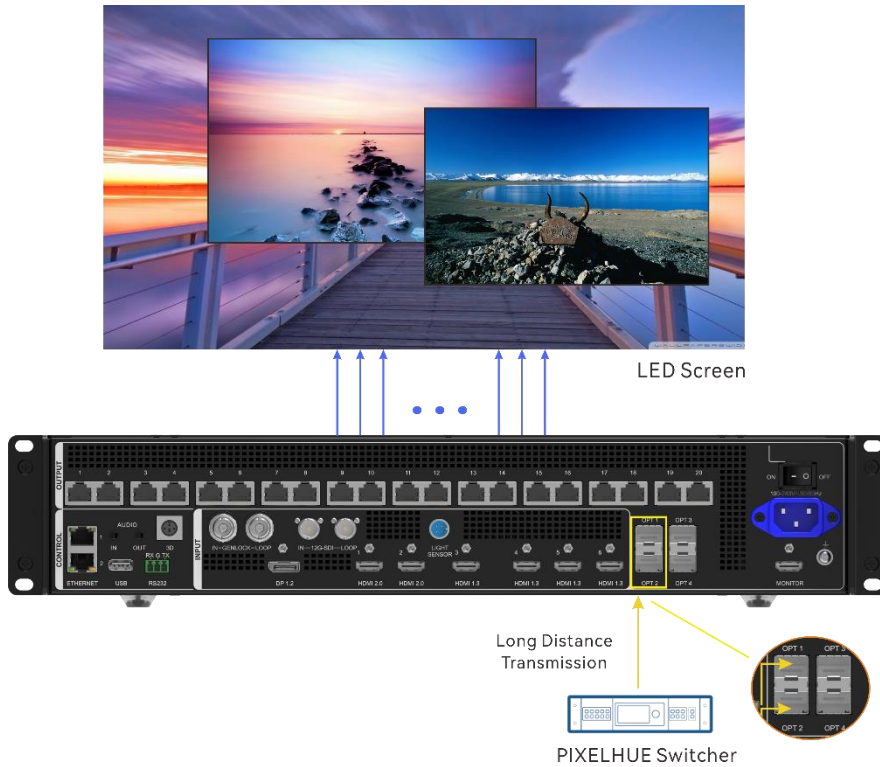

## 5.6 Input Settings

The input settings allow you to switch the input connector capacity, set input resolution and InfoFrame override parameters, as well as configure mosaic sources.

Figure 5-10 Input settings

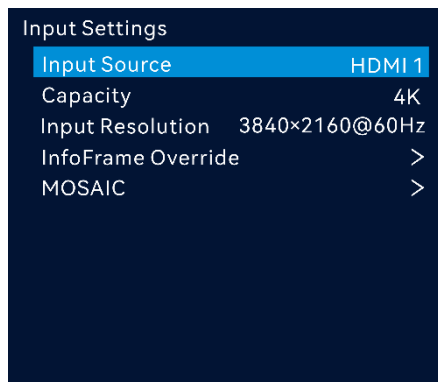

## 5.6.1 Switch Connector Capacity

Switch the input connector capacity to allow the device to calculate the number of layers that can be added based on the capacity.

### Prerequisites

You have selected an input source.

### Notes

Changing the connector capacity of the OPT source is not supported.

### Screen Example

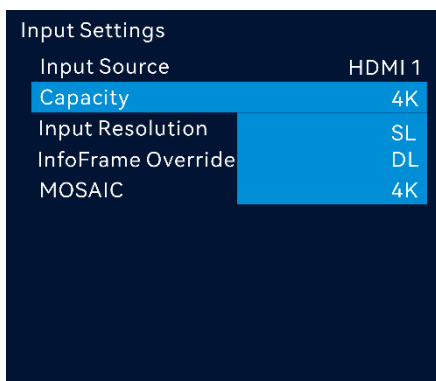

### Operating Procedure

- Step 1 On the input settings screen, rotate the knob to select **Input Source** and press the knob to display the input source list.
- Step 2 Rotate the knob to select the desired input source and press the knob to confirm.
- Step 3 Rotate the knob to select **Capacity** and press the knob to display the capacity list.

Table 5-3 Connector capacity limitations

Connector Capacity	Description
SL	<ul style="list-style-type: none"> <li>• Standard resolution: 1920×1080@60Hz</li> <li>• Custom max width: 2048 (2048×1080@60Hz)</li> <li>• Custom max height: 2048 (1080×2048@60Hz)</li> </ul>

Connector Capacity	Description
DL	<ul style="list-style-type: none"> <li>Standard resolution: 3840×1080@60Hz/3840×2160@30Hz</li> <li>Custom max width: 4096 (4096×1080@60Hz)</li> <li>Custom max height: 3840 (1080×3840@60Hz)</li> </ul>
4K	<ul style="list-style-type: none"> <li>Standard resolution: 4096×2160@60Hz/8192×2160@30Hz</li> <li>Custom max width: 8192 (8192×1080@60Hz)</li> <li>Custom max height: 8188 (1080×8188@60Hz)</li> </ul>

 Note

If the resolution of an input source is larger than the max width limit of the connector capacity, you need to switch the connector capacity to ensure that the input source can be processed normally.

Step 4 Rotate the knob to select the target capacity and press the knob to confirm.

## 5.6.2 Set Input Resolution

Set the input resolution and frame rate. The options include **Standard** and **Custom**.

### Prerequisites

- The front-end device outputs the video source from the graphics card.
- You have selected an HDMI or DP source. SDI does not support this function.

### Screen Example

Figure 5-11 Standard resolution

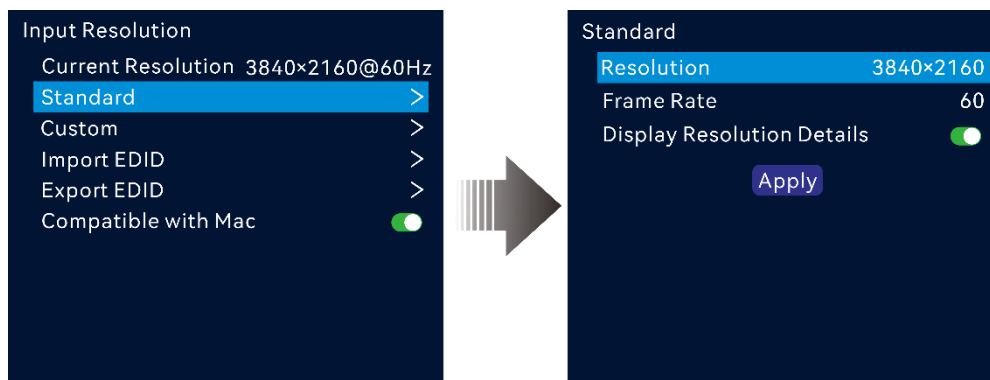
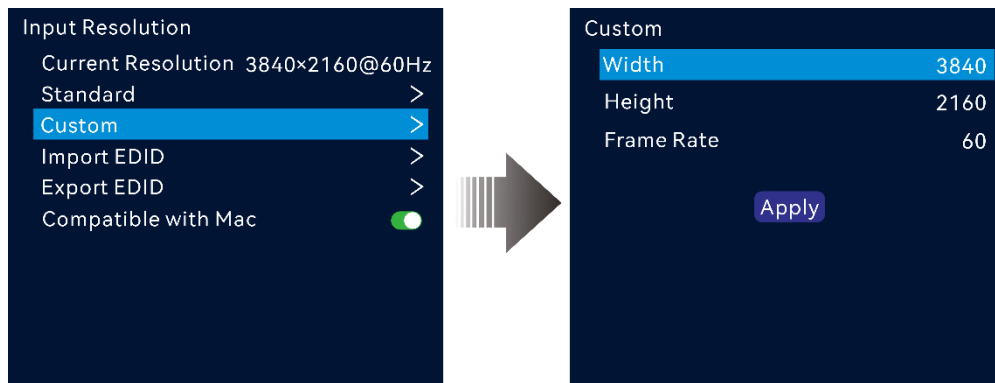

Figure 5-12 Custom resolution



## Operating Procedure (Standard Res)

- Step 1 On the input settings screen, select the desired input source and press the knob to confirm.
- Step 2 On the input resolution settings screen, select **Standard**.
- Step 3 Rotate the knob to select **Resolution**, and press the knob to show the resolution list.
- Step 4 Rotate the knob to select the desired resolution from the list and then press the knob to confirm.
- Step 5 Rotate the knob to select the desired frame rate from the list and then press the knob to confirm.
- Step 6 (Optional) Rotate the knob to select **Display Resolution Details** and press the knob to turn on the switch.
- Step 7 Rotate the knob to select **Apply** and press the knob to complete the standard resolution settings.

## Operating Procedure (Custom Res)

- Step 1 On the input settings screen, select the desired input source and press the knob to confirm.
- Step 2 On the input resolution settings screen, select **Custom**.
- Step 3 Rotate the knob to select **Width** and press the knob to confirm. Rotate the knob again to select the desired width and press the knob to confirm.
- Step 4 Rotate the knob to select **Height** and press the knob to confirm. Rotate the knob again to select the desired height and press the knob to confirm.
- Step 5 Rotate the knob to select **Frame Rate** and press the knob to show the frame list. Rotate the knob again to select the desired frame rate and press the knob to confirm.

Step 6 Rotate the knob to select **Apply** and press the knob to complete the custom resolution settings.

### 5.6.3 Import and Export EDID

If you encounter a compatibility problem with an input connector, you can resolve it by importing a compatible EDID file into the device. You can also export an EDID file from the device and providing it to other devices or input connectors.

#### Prerequisites

- Before importing the EDID file, you have saved the file (.bin and .dat) to the root directory in an USB drive and inserted it into the device USB port.
- Before exporting the EDID file, you have inserted an USB drive into the device USB port.
- You have selected an accessed input source. SDI connector does support this function.

#### Notes

- Each input connector supports importing one EDID file only.
- Once the EDID file is imported, the input connector will recognize and apply the parameters from the file.

#### Screen Example

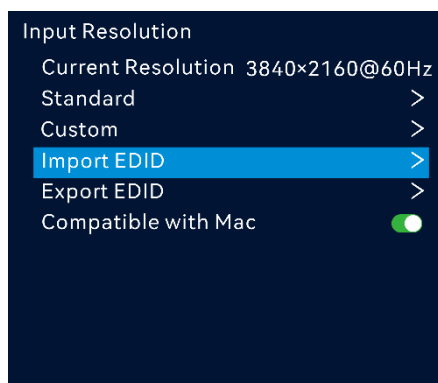

#### Operating Procedure (Import EDID)

Step 1 On the input resolution settings screen, rotate the knob to select **Import EDID** and press the knob to enter the EDID file list screen.

Step 2 Select the desired file and press the knob to confirm

Step 3 In the popup dialog, select **OK** to import the EDID file.

### Operating Procedure (Export EDID)

Step 1 On the input resolution settings screen, rotate the knob to select **Export EDID** and press the knob to enter the EDID file exporting screen.

Step 2 Select the file format (.bin or .dat) and press the knob to confirm.

Step 3 Select **Apply** to apply the parameters saved in the file.

#### Note

If you need to modify the content of an imported EDID file, just modify it and then re-import it to overwrite the original one.

### 5.6.4 Compatible with Mac

When the device is incompatible with the EDID of a Mac system, you may activate this feature to resolve the issue.

#### Screen Example

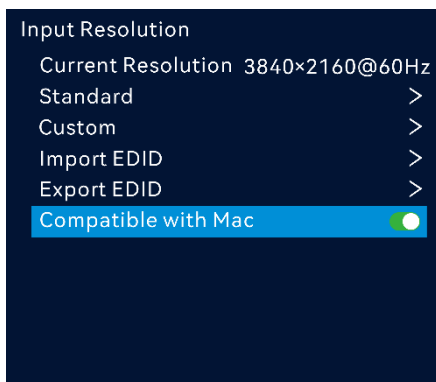

#### Parameter Descriptions

Parameter	Description
Compatible with Mac	Turn on or turn off the function. •  : On

Parameter	Description
	<ul style="list-style-type: none"> <li><input type="checkbox"/> Off</li> </ul>

### 5.6.5 Configure InfoFrame Override Parameters

Set the InfoFrame override parameters for the input source, allowing the device to use them during calculations. This won't alter the input source's original parameter values.

#### Parameter Description

You have selected an HDMI or DP source. SDI does not support this function.

#### Screen Example

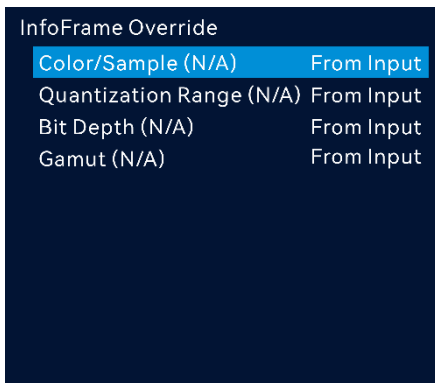

#### Operating Procedure

- Step 1 On the input settings page, rotate the knob to select **InfoFrame Override** and press the knob to enter the corresponding screen.
- Step 2 Rotate the knob to set the color/sample of the input source and press the knob to confirm.
- Step 3 Rotate the knob to set the quantization range of the input source and press the knob to confirm.

#### Parameter Descriptions

Menu	Description
Color/Sample	<p>The sampling format of the input</p> <p>The supported options include <b>RGB 4:4:4</b>, <b>YCbCr 4:2:2</b>, <b>YCbCr 4:4:4</b> and</p>

Menu	Description
	<b>From Input.</b>
Quantization Range	The quantization range of the input The supported options include <b>From Input, Limited</b> and <b>Full</b> .
Bit Depth	The bit depth of the input, i.e., the binary digits to represent a single color The supported options include <b>From Input, 8bit, 10bit</b> and <b>12bit</b> .
Gamut	The gamut standard of the input The supported options include <b>Rec.601, Rec.709, DCI-P3(D65), Rec.2020</b> and <b>From Input</b> .

 Note

Select **From Input** and the device will read the attribute values that come with the input source.

## 5.6.6 Configure Mosaic Sources

Both HDMI and OPT sources support mosaicing.

### Notes

- Only the VX2000 Pro supports this function.
- Only the input sources of the same connector type support mosaicing, and the frame rates of sub-source must be the same.



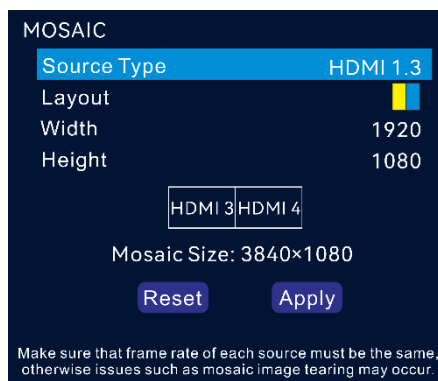

















### Screen Example



## Operating Procedure

- Step 1 On the input settings screen, rotate the knob to select **MOSAIC** and press the knob to enter the mosaic source settings screen.
- Step 2 Rotate the knob to select **Source Type** and press the knob to confirm.
- Step 3 Select the desired mosaic layout.
- Step 4 Set **Width** and **Height** for each mosaic area.
- If the input source width or height is less than the width or height value you set, the blank area will be filled with solid black.
  - If the input source width or height is larger than the width or height value you set, the input source image will be cropped. The cropping takes the top left corner of the input source image as the reference point and then crops the image according to the set width and height values.
  - The total width and height of the mosaic source will be displayed.
- Step 5 Rotate the knob to select the mosaic layout area and press the knob to select sub-sources of each mosaic area.
- Step 6 Rotate the knob to select **Apply** to make the settings take effect; otherwise, select **Reset** to reset the settings to defaults.

## Parameter Descriptions

Parameter	Description
Source type	<p>The connector type of the sub sources</p> <p>The supported options include <b>HDMI 2.0</b>, <b>HDMI 1.3</b> or <b>OPT</b>.</p> <p> Note</p> <p>Each OPT port supports transmission of 2x SL or 1x DL source.</p>
Layout	<p>The mosaic layout</p> <p>The layout varies depending on the source type.</p> <ul style="list-style-type: none"> <li>• For <b>HDMI 2.0</b>, three layouts are supported: "  ", "  " and "  "</li> <li>• For <b>HDMI 1.3</b>, eight layouts are supported: "  ", "  ", "  ", "  ", "  ", "  ", "  " and "  "</li> <li>• For <b>OPT</b>, eight layouts are supported: "  ", "  ", "  ", "  ", "  ", "  ", "  " and "  "</li> </ul>

Parameter	Description
Width	The width of the individual mosaic area Default value: 1920 pixels
Height	The height of the individual mosaic area Default value: 1080 pixels
Mosaic Size	The size of the mosaic source <ul style="list-style-type: none"> <li>• Max. width: 8192 pixels</li> <li>• Max. height: 8192 pixels</li> <li>• Max. width and height: 4096×2160</li> </ul>

 Note

The mosaic source capacity depends on the max capacity and number of sub-sources, that is, the capacity of a mosaic source composed of two DL sub-sources or SL+4K sub-sources is 4K.

## 5.7 Preset Settings

A preset is a set of parameters that save the layer and layer-related information. Up to 256 user-defined presets are supported. After a preset is saved, you can load the preset simply by its name. The preset operations include **Save**, **Load** and **Delete**.

### Screen Example

Figure 5-13 Preset settings

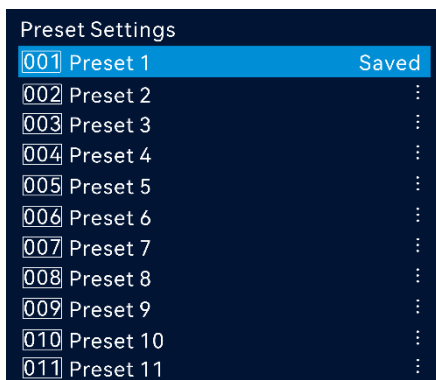

### 5.7.1 Save Presets

After the layer settings, you can save those settings as a preset.

## Screen Example

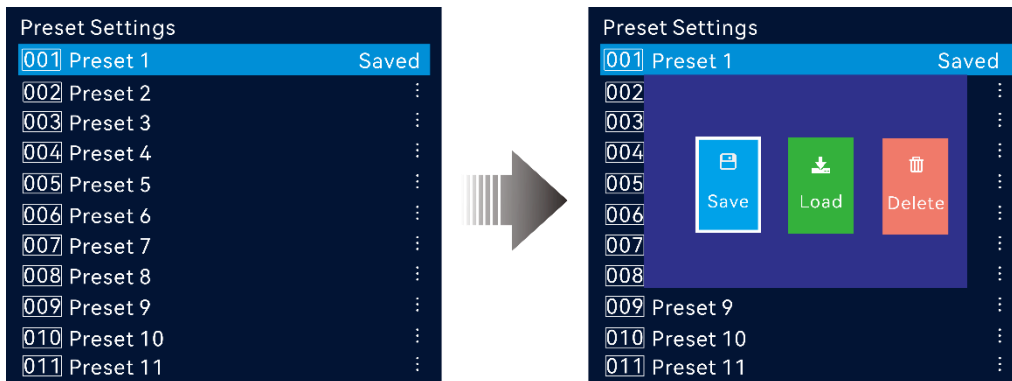

## Operating Procedure

- Step 1 On the preset settings screen, rotate the knob to select a preset.
- Step 2 Press the knob to open the preset operations window.
- Step 3 Rotate the knob to select **Save** and press the knob to save the layer settings to this preset.

After a preset is saved, the preset status on the right side changes to **Saved**.

## 5.7.2 Load Presets

This operation allows you to send a saved preset to an LED screen.

## Screen Example

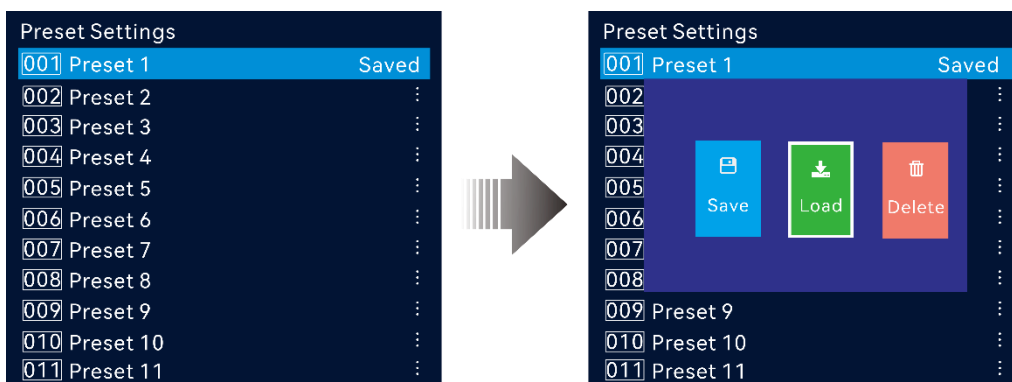

## Operating Procedure

- Step 1 On the preset settings screen, rotate the knob to select a saved preset.

Step 2 Press the knob to open the preset operations window.

Step 3 Rotate the knob to select **Load** and press the knob to load the preset.

After a preset is loaded, the preset status on the right side changes to **In Use**.

 Note

Press the **PRESET** button on the front panel to quickly enter the preset setting screen. You can press a number button to quickly load the corresponding preset.

### 5.7.3 Delete Presets

This operation allows you to clear the data saved in the preset. The preset name will not be cleared.

#### Screen Example

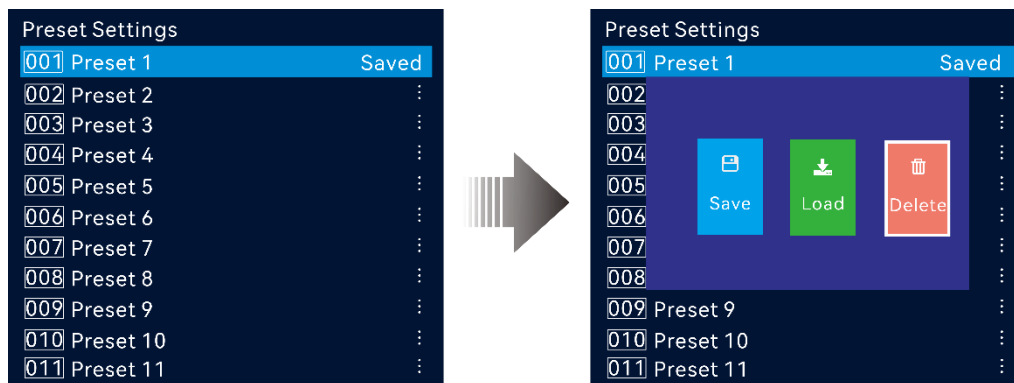

#### Operating Procedure

Step 1 On the preset settings screen, rotate the knob to select a saved preset.

Step 2 Press the knob to open the preset operations window.

Step 3 Rotate the knob to select **Delete** and press the knob to open a confirmation window.

Step 4 Rotate the knob to select **Yes** and press the knob to delete the preset.

## 5.8 Image Mosaic

When the LED screen cannot be loaded by a single device, you can mosaic multiple devices to expand the system overall loading capacity. This allows to drive a screen with larger physical areas and higher total pixels.

### Connection Method

Figure 5-14 VX2000 Pro

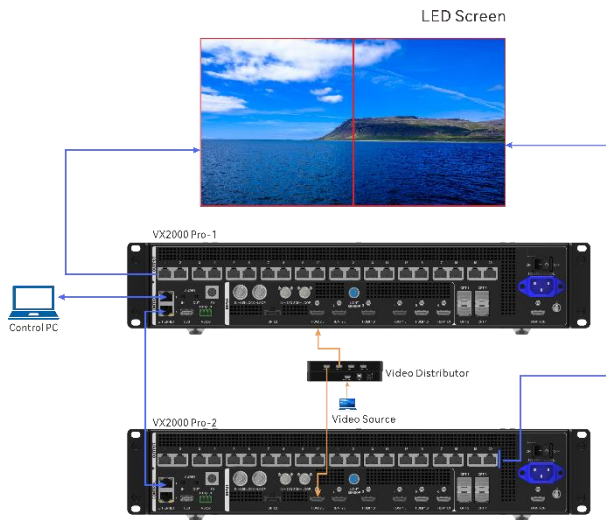
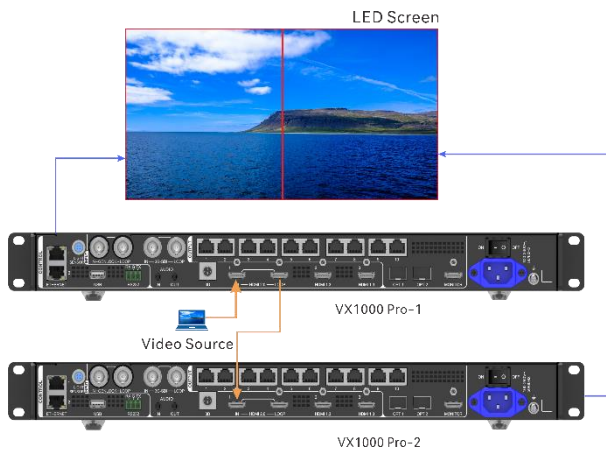

Figure 5-15 VX1000 Pro



### Prerequisites

None

## Notes

- It is advisable to use devices of the same type to load the screen. Otherwise, there will be seams between mosaic screens.
- To ensure image sync between mosaic screens, the system will use the layer 1 source as the sync source by default after you enable the image mosaic function. Please ensure that the signal source in use is stable and reliable.
- After enabling the image mosaic function, any changes made to layer 1 parameters will cause this function to be automatically disabled.

## Screen Example

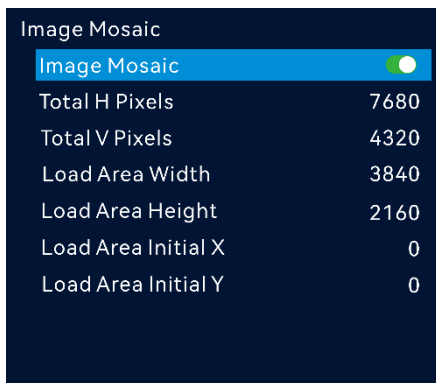

## Operating Procedure

- Step 1 On the main menu screen, rotate the knob to select **Image Mosaic** and press the knob to enter the image mosaic settings screen.
- Step 2 Rotate the knob to select **Image Mosaic** and press the knob to confirm. Rotate the knob again to select **On** and press the knob to confirm.
- Step 3 Set the mosaic-related parameters for each device.
  - Total H Pixels: The number of pixels in the horizontal direction of the LED screen
  - Total V Pixels: The number of pixels in the vertical direction of the LED screen
  - Load Area Width: The number of pixels in the horizontal direction of the area loaded by the current device
  - Load Area Height: The number of pixels in the vertical direction of the area loaded by the current device

- Load Area Initial X: The initial horizontal coordinate of the top-left corner of the area loaded by the current device. The unit is pixel.
- Load Area Initial Y: The initial vertical coordinate of the top-left corner of the area loaded by the current device. The unit is pixel.

## 5.9 Display Control

### Notes

If the freeze or FTB function is turned on, the test pattern function is unavailable.

### Screen Example

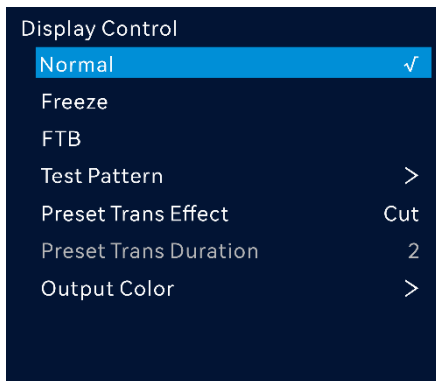

### Parameter Descriptions

Menu	Sub-Menu	Description
Normal	-	Display the content of the current input source.
Freeze	-	Freeze the current frame of the output image.
FTB	-	Make the output image fade to black.
Test Pattern	Pure Color	The pure color test pattern
	Gradient	The gradient test pattern
	Grid	The grid test pattern
	Brightness	The brightness of the test pattern
	Spacing Level	Set the spacing between different color areas. If a multi-color test pattern is selected, this parameter is available.

Menu	Sub-Menu	Description
	Spacing (px)	Set the spacing between the lines. If a grid test pattern is selected, this parameter is available.
	Line Width	Set the width of the grid lines. If a grid test pattern is selected, this parameter is available.
	Speed	Set the moving speed of the lines. If a grid test pattern is selected, this parameter is available.
Preset Trans Effect	-	<p>Set the preset switching effect. The supported options include <b>Cut</b> and <b>Fade</b>.</p> <ul style="list-style-type: none"> <li>• Cut: Switch one preset to another with no transition effect.</li> <li>• Fade: Switch one preset to another with a fade effect.</li> </ul> <p>After selecting <b>Fade</b> effect, you can set the transition duration. The value ranges from 1s to 3s and it defaults to 2s.</p> <div style="background-color: #f0f0f0; padding: 5px;"> <p> <b>Note</b></p> <ul style="list-style-type: none"> <li>• The fade effect takes effect on presets with less than 7x SL layers only.</li> <li>• Only the VX2000 Pro supports setting of the preset switching effect.</li> </ul> </div>
Output Color	Brightness	The shading of lights in the image Adjust the brightness value either as a whole or individually adjust the RGB components.
	Contrast	The ratio of the luminance of the brightest color to that of the darkest color Adjust the contrast value either as a whole or individually adjust the RGB components.
	Saturation	The color purity of the image The higher the value, the more vivid the color.
	Hue	The relative degree of how bright or dark the image is

## 5.10 USB Playback

Play images or videos saved in a USB drive and configure the playback parameters. A USB source can be used as a layer source.

The models of devices that support USB playback and the corresponding output resolutions for USB sources are listed below.

Device Model	USB Source Resolution
VX400 Pro	1920×1080@60Hz
VX600 Pro	
VX1000 Pro	
VX2000 Pro	3840×2160@60Hz

 Note

Press the desired layer button in the **LAYER** area on the device front panel and then press the **U-DISK** button to use a USB source to open a layer.

## 5.10.1 USB Player

### Prerequisites

A USB drive has been inserted and recognized in the U-DISK connector on the front panel.

### Notes

Up to 128 files can be displayed in the playlist and the size of each file cannot exceed 128 GB.

### Screen Example

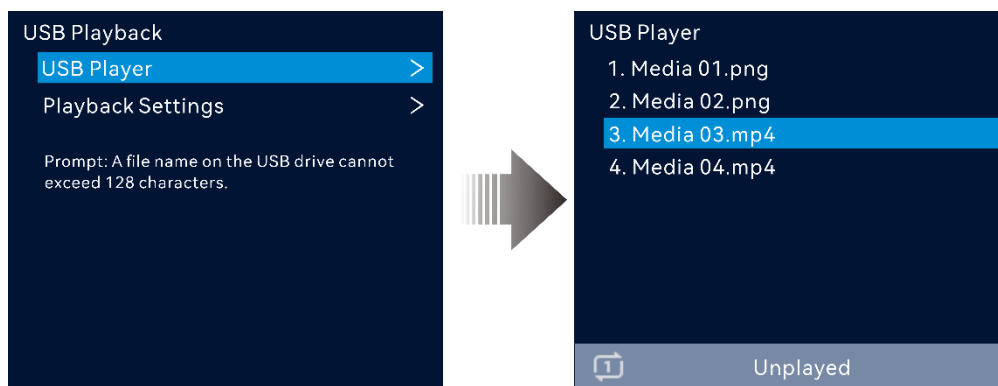

### Operating Procedure

Step 1 On the main menu screen, go to **USB Playback** > **USB Player** to enter the USB player screen.

Step 2 Rotate the knob to select the desired the file and press the knob to play the file or stop the playback.

The items displayed on this screen are as follows.

- Media files in compatible formats
- The playback mode
- The playback status

## 5.10.2 Playback Settings

Configure the playback-related parameters.

### Screen Example

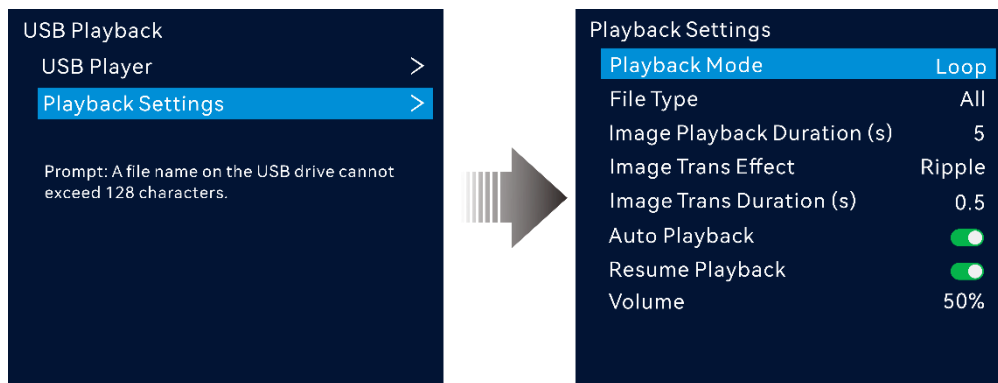

### Limitations

- Single-partition USB drive supported
- File system: NTFS, FAT32 and exFAT
- Max. width and height of media files  
Width: 3840 pixels, height: 2160 pixels
- Picture format: jpg, jpeg, png and bmp
- Decoded image resolution: 3840×2160 or lower
- Video format: mp4, mkv, mov, avi, flv, m4v, mpg, mpeg, ts
- Video coding: H.264, H.265, MPEG-2, MPEG-4
- Max. video frame rate:  
H.264: 3840×2160@30fps, H.265: 3840×2160@60fps

MPEG-2/MPEG-4: 1920×1080@60fps

- Max bitrate:

H.264/H.265: 100Mbps

MPEG-2/MPEG-4: 50Mbps

- Audio coding: AAC, AC3, DTS, MP3, DVD, DVD\_LPCM, MP2, OPUS



- Audio sampling rate:

opus: 24kHz, 48kHz

Other formats: 22.05kHz to 94kHz

## Parameter Descriptions

Parameter	Description
Playback Mode	<p>The playback mode of the file</p> <ul style="list-style-type: none"> <li>• Loop: Play the files in the playlist in order. Once the playback of the last file is completed, replay the first file.</li> <li>• Play in Order: Play the files in the playlist in order. Once the playback of the last file is completed, the screen will display a black image and the playback will stop.</li> <li>• Repeat One: Loop playback of the current file.</li> </ul>
File Type	<p>The type of the playback file</p> <ul style="list-style-type: none"> <li>• Video</li> <li>• Image</li> <li>• All: Videos and images</li> </ul> <p> <b>Note</b></p> <p>After the file type is selected, only the file of the selected type will be displayed in the playlist.</p>
Image Playback Duration (s)	<p>The duration of the image playback</p> <p>The value ranges from 1 to 60 and it defaults to 5. (Unit: s)</p>
Image Trans Effect	<p>The trans effect of the image</p> <p>Supported trans effect: Ripple, zoom in, cut out, flip, blinds, H wipe, V wipe, cube, dissolve, grid, swapping, scroll, fade in/out, twirl, heart trans, doorway, perspective triangle, disappear, bounce, pinwheel and random</p>
Image Trans Duration (s)	<p>The trans duration of the image</p> <p>The value ranges from 0.5 to 2 and it defaults to 0.5. (Unit: s)</p>

Parameter	Description
Auto Playback	<p>Set whether to automatically play the USB files after the device is powered off and then power on with a USB drive inserted.</p> <ul style="list-style-type: none"> <li> On</li> </ul> <p>If <b>Resume Playback</b> not enabled, replay the files in the playlist in order; If enabled, replay the file being played before power failure from the beginning.</p> <ul style="list-style-type: none"> <li> Off</li> </ul>
Resume Playback	<ul style="list-style-type: none"> <li>On: If a file is playing before the device power failure, enabling this function allows to replay the file from beginning after the device is powered on with a USB drive inserted.</li> <li>Off: Replay the files in the playlist in order.</li> </ul> <div style="background-color: #f0f0f0; padding: 5px; margin: 5px 0;">  Note         </div> <ul style="list-style-type: none"> <li>Enabling <b>Resume Playback</b> will also activate the <b>Auto Playback</b> feature at the same time.</li> <li>After <b>Resume Playback</b> is enabled, if the file being played before power failure cannot be found, the files will be played from the beginning of the playlist in order.</li> </ul>
Volume	<p>Playback volume of a media file</p> <p>The value ranges from 0 to 100 and it defaults to 50%.</p>

## 5.11 Advanced Settings

### 5.11.1 End-to-End Backup

The end-to-end backup is supported, including device backup, input source backup and Ethernet port backup test, stable and reliable.

#### 5.11.1.1 Device Backup

The backup between devices and Ethernet ports are both supported.

##### 5.11.1.1.1 Backup Between Devices

Device backup allows you to set the backup relationship between two devices. You can set one of the devices as the primary device or the backup device. When the primary device has a

problem or the primary device's Ethernet cable fails, the backup device will take over the responsibilities of the primary device seamlessly and continue to work well to ensure the LED screen will not go black.

## Prerequisites

- Before creating a backup relation, make sure that both the primary and backup devices are on the same LAN.
- In a backup relation, the models and device versions of the primary and backup devices must be the same.

## Notes

- You have three options to create a backup relation: NovaLCT, Unico, or the device LCD menu. However, be aware that these methods do not synchronize with each other. Using more than one can lead to data problems. To prevent issues, choose only one method for setting up your backup. If you do mix them, you'll need to reset the device to factory settings and start over with just one method.
- In the device backup mode, the quantity of the cabinets loaded by each Ethernet port on both the primary and backup devices must be the same, but their data flow must be in a reversed way.

## Hardware Connections

The diagram takes the VX2000 Pro as an example.

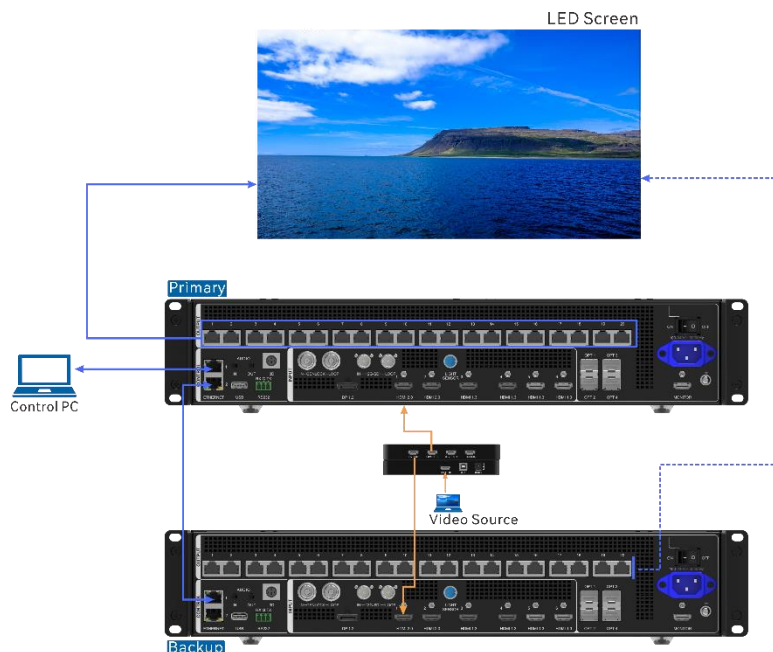

## Screen Example

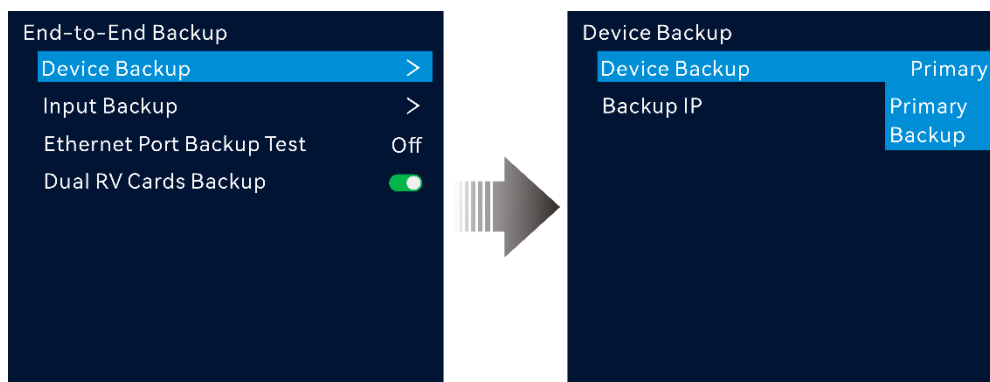

## Operating Procedure

**Step 1** On the main menu screen, go to **Advanced Settings > End-to-End Backup > Device Backup** to enter the device backup screen.

The available devices on the same LAN will be automatically searched.

**Step 2** Set the primary device.

**Step 3** Rotate the knob to select **Backup IP** and press the knob to display the backup IP list. Select the desired IP address of a device to be set as a backup one.

### Note

- After a backup relation is created, the configuration parameters (except communication settings) of the primary device will be automatically synchronized to the backup device.

- After a backup relation is created, you can adjust the screen parameters on the front panel of the backup device without unbinding the backup relationship when the primary device is powered off.

### 5.11.1.1.2 Backup Between Ethernet Ports

Ethernet port backup allows you to set the backup relationship between two Ethernet ports. When the primary port has a problem or the primary port's Ethernet cable fails, the backup port will take over the responsibilities of the primary port seamlessly and continue to work well to ensure the LED screen will not go black. When setting the backup between the Ethernet ports, you need to complete it in NovaLCT.

### Hardware Connections

This diagram takes the VX2000 Pro as an example.

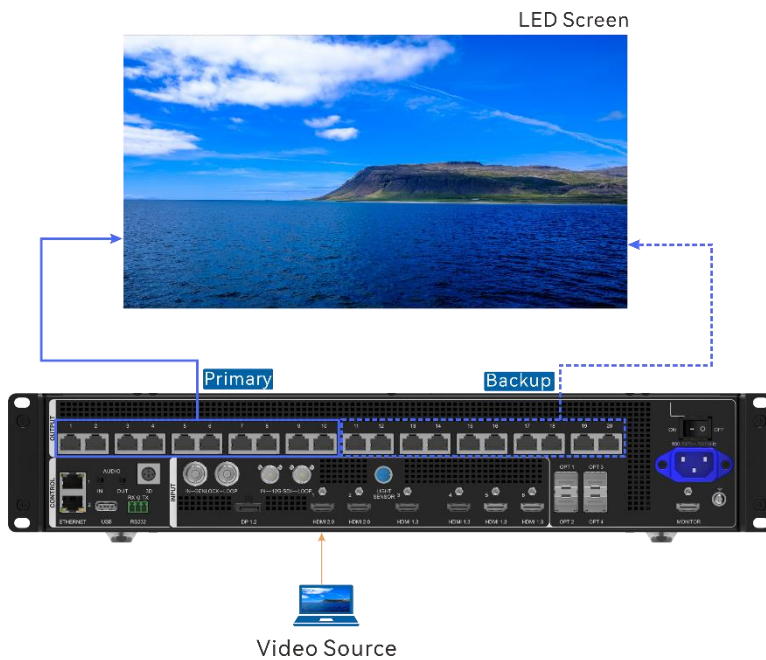

### Operating Procedure

- Step 1 Run the NovaLCT software. On the menu bar, go to **User > Advanced Synchronous System User Login**. Enter the password and click **Login**.
- Step 2 Click **Screen Configuration** to enter the screen configuration page.
- Step 3 Click **Next** to enter the screen configuration page.

Figure 5-16 Screen configuration



Step 4 Select the **Sending Card** tab, and then click **Add** in the **Redundancy** area.

Step 5 Set the serial numbers of both the primary device and backup device to **1**.

Step 6 Set the serial number of the primary port and the serial number of the corresponding backup port.

Figure 5-17 Ethernet port backup

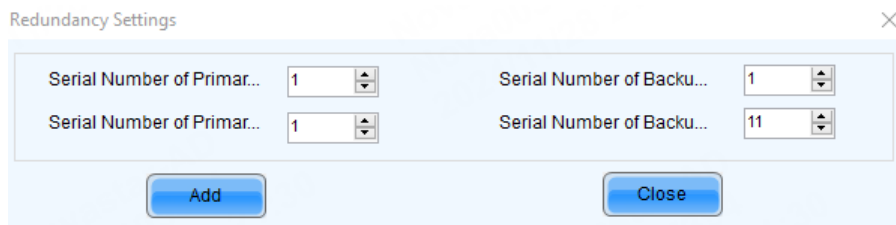

Step 7 Click **Add** to complete the backup settings of an Ethernet port, and the system will automatically list the primary ports and backup ports.

Figure 5-18 Primary Ethernet ports

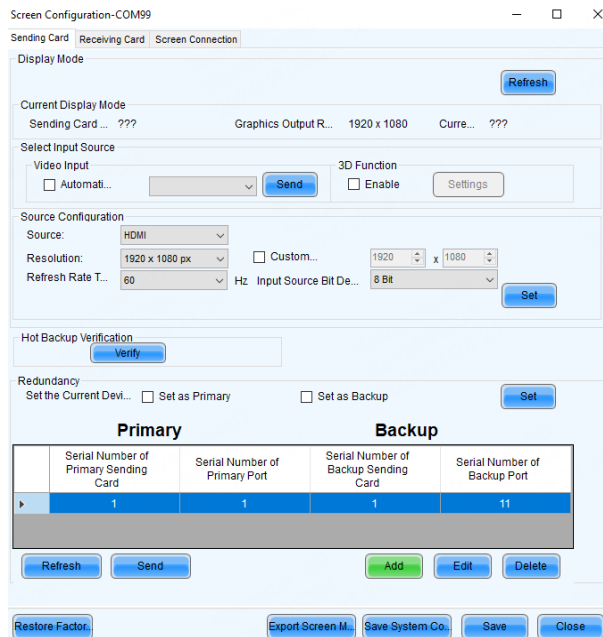

Step 8 Repeat Step 6 and Step 7 to complete the backup settings for other Ethernet ports.

### 5.11.1.2 Input Backup

Input backup allows you to set the backup relationship between two input sources. When one input source has a problem or the input connector fails, the backup source will be used seamlessly and continue to work well to ensure the LED screen will not go black.

#### Notes

Input backup rules:

- In each backup group, two input sources serve as the backup for each other.
- The backup relation can only be established if the input connectors have identical capacities.
- The USB source supports the input backup settings.
- Each primary or backup source can have only one backup or primary source.
- Restrictions on input backup functions:

Input sources A and B form a hot backup group. The current input source of the layer is input source A.

- Input A: No signal. Input B: Signal

The layer input source is switched to input B automatically. When input A resumes and input B still has a signal and **Primary Source Preferred** is not enabled, the layer input source will not be changed.

- Input A: No signal. Input B: Signal

The layer input source is switched to input B automatically. When input A resumes, but input B does not have a signal, the layer input source will be changed to input A.

- Input A: No signal. Input B: No signal

The layer input source will not be changed.

- Input A: Signal. Input B: No signal

If you manually switch the layer input source to input B, the source will automatically switch to input A.

## Screen Example

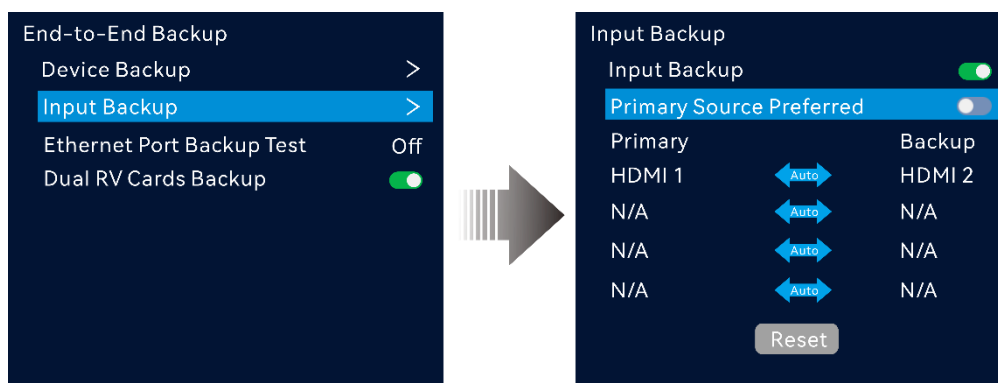

## Operating Procedure

- Step 1 On the main menu screen, go to **Advanced Settings > End-to-End Backup > Input Backup** to enter the input backup settings screen.
- Step 2 Rotate the knob to select **Input Backup** and press the knob to turn on the function.
- Step 3 Rotate the knob to select the desired primary input source on the left side.
- Step 4 Rotate the knob to select the desired backup input source on the right side.
- Step 5 (Optional) Set the primary source preferred.
  - On: The primary source will always be used if there is a signal. When the primary source fails, the layer input source is switched to the backup one automatically. Once the primary source resumes, the layer input source seamlessly switches back to the primary source.

- Off: The layer input source will be switched to the primary source only when the backup one fails and the primary one has a signal.

### 5.11.1.3 Ethernet Port Backup Test

Test whether the pre-stored images, backup Ethernet ports and devices take effect without plugging and unplugging the Ethernet cables.

#### Prerequisites

The pre-stored images, primary and backup Ethernet ports or primary and backup devices have been configured.

#### Screen Example

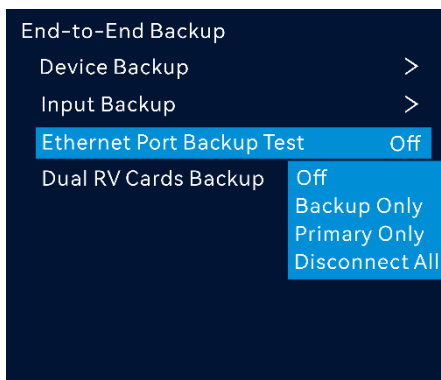

#### Parameter Descriptions

Parameter	Description
Off	Enable the output of all the Ethernet ports on the current device to complete the test.
Backup Only	Disable the output of the primary Ethernet port on the current device to test whether the backup port or device takes effect.
Primary Only	Disable the output of the backup Ethernet port on the current device to test whether the output of the primary port is normal.
Disconnect All:	Disable the output of all the Ethernet ports on the current device to test whether the pre-stored image takes effect.

### 5.11.1.4 Dual RV Cards Backup

Receiving card backup allows you to set the backup relationship between two receiving cards. If the primary receiving card link fails, the backup one will take over the responsibilities of the primary receiving card and continue to work well to ensure the LED screen will not go black.

#### Prerequisites

Two receiving cards are connected to the cabinet.

#### Notes

When you enable both the device backup and dual receiving cards backup, the former takes precedence over the latter. When the layer sources of two devices are disconnected, the device will switch to the backup receiving card link.

#### Screen Example

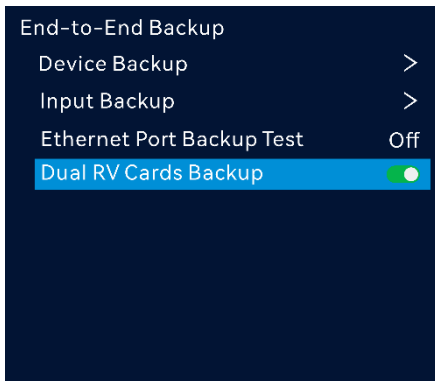

#### Parameter Descriptions

Parameter	Description
Dual RV Cards Backup	Turn on or turn off the function. <ul style="list-style-type: none"> <li>• : On</li> <li>• : Off</li> </ul>

## 5.11.2 Synchronization

This function allows you to select a synchronization signal to synchronize all the cascaded device units or synchronize the primary and backup devices to display the output images of all the units in sync.

### Notes

- The input source with or without signal can be used as a sync source. When a no signal source is used, the sync fails.
- Synchronizing to a DP source is supported by the VX2000 Pro only.
- Before enabling the Genlock sync function, make sure the sync signal has been connected to the Genlock connector of the device.

### Screen Example

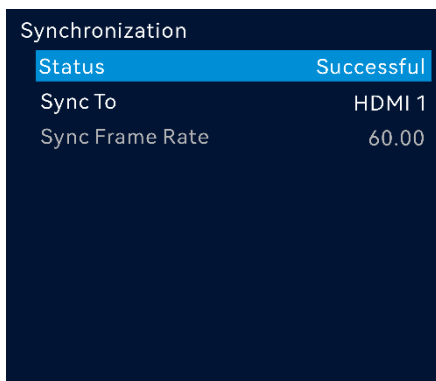

### Operating Procedure

- Step 1 On the main menu screen, go to **Advanced Settings > Synchronization** to enter the synchronization settings screen.
- Step 2 Rotate the knob to select **Sync To** and press the knob to display the sync source list. The options include **Internal**, an input source connected to the device's video connector and **Genlock**. ("X" represents the input source number and its format may vary depending on the actual setup.)
  - Internal: The frame rate of the output image
  - An input source connected to the device's video connector: Sync with the frame rate of the selected input source. After a sync source is selected, the sync frame rate will be displayed.

- Genlock: Sync with the frame rate of the Genlock signal.

Step 3 (Optical) If **Internal** is selected, you can manually set the output frame that defaults to 60Hz.

Once the synchronization is successful, the screen will show **Successful**

### 5.11.3 Audio Settings

This function allows you to set the audio status, output audio, volume and input audio.

#### Hardware Connections

The diagram takes the VX2000 Pro as an example.

- Via a multifunction card

Connect the Ethernet port 1 or 2 to a multifunction card, and then connect the multifunction card to an external speaker.

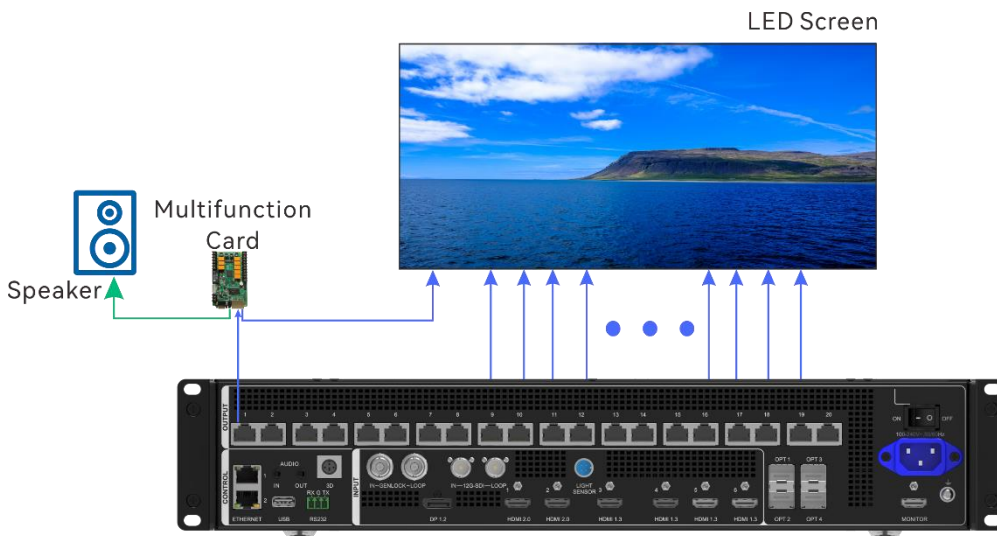

- Via the audio output connector

Connect the audio output connector to an external speaker.

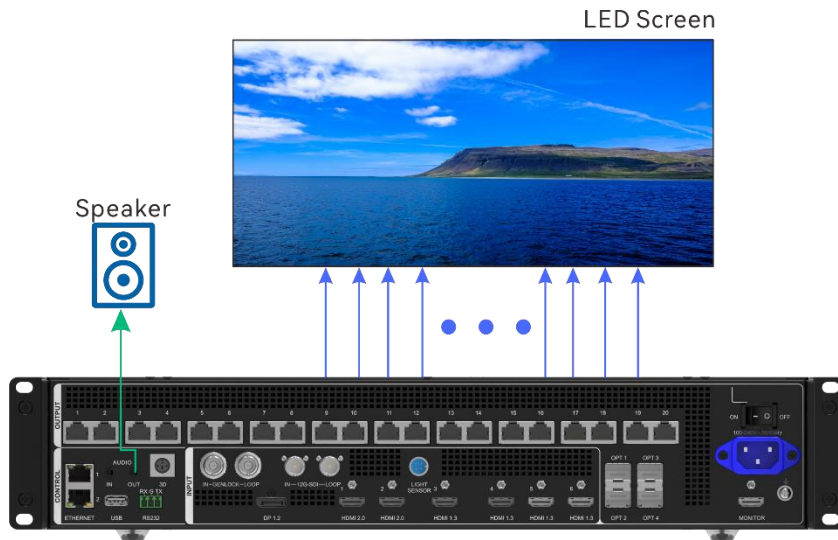

## Screen Example

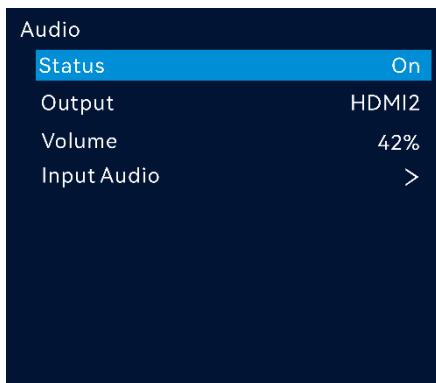

### 5.11.3.1 Set Audio Status

Turn on or turn off the audio.

## Screen Example

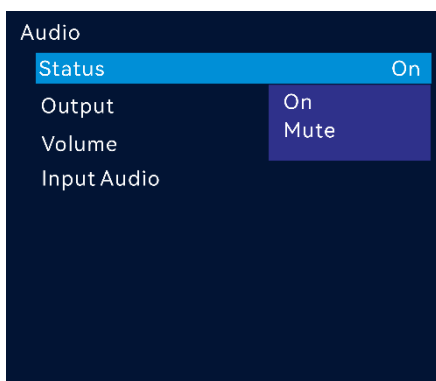

## Operating Procedure

- Step 1 On the main menu screen, go to **Advanced Settings > Audio** to enter the audio settings screen.
- Step 2 Rotate the knob to select **Status** and press the knob to confirm.
- Step 3 Rotate the knob to select **On** or **Mute** to turn on or turn off the audio.

### 5.11.3.2 Select Output Audio

Set to output the layer audio, analog audio or embedded audio of an input source.

#### Screen Example

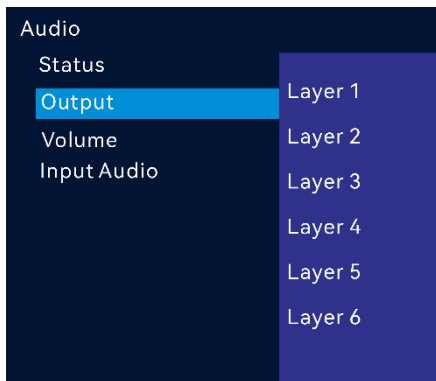

## Operating Procedure

- Step 1 On the main menu screen, go to **Advanced Settings > Audio > Output** and press the knob to display the output audio list.
- Step 2 Select the desired output audio and press the knob to confirm.
  - Layer n: Output the audio of the current layer input source. When you switch the current layer input source, the audio will also be changed.
  - Audio In: Output the analog audio coming from an external audio device. When you switch the current layer input source, the audio will not be changed.
  - Embedded audio of an input source: Output the fixed embedded audio. When you switch the current layer input source, the audio will not be changed.

The supported input source types include HDMI sources, DP sources, and USB sources.

 Note

The input source audio of the layer 1 is output by default.

### 5.11.3.3 Set Output Volume

Adjust the output volume.

#### Screen Example

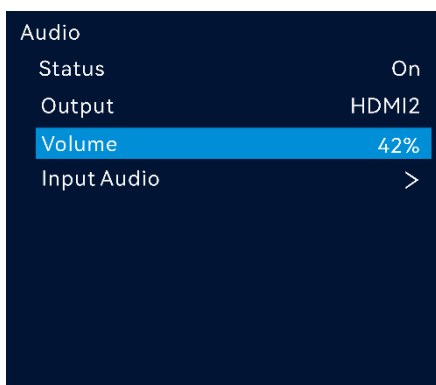

#### Operating Procedure

- Step 1 On the main menu screen, go to **Advanced Settings > Audio** to enter the audio settings screen.
- Step 2 Rotate the knob to select **Volume** and press the knob to confirm. Then rotate the knob again to adjust the audio volume and press the knob to confirm.

#### Parameter Descriptions

Parameter	Description
Volume	The output volume The value ranges from 0 (silent) to 100 (loudest) and defaults to 50.

### 5.11.3.4 Set Input Source Audio

Bind audio sources of different types to video sources. When you switch the layer source, the audio source will be synchronously changed.

## Screen Example

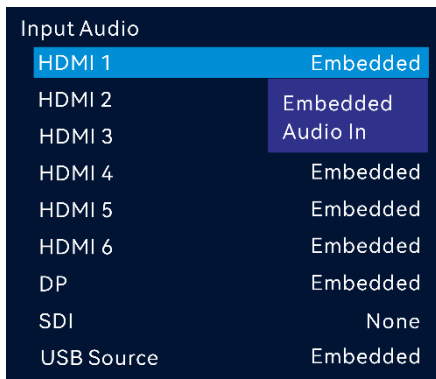

## Operating Procedure

- Step 1 On the main menu screen, go to **Advanced Settings > Audio > Input Audio** and press the knob to enter the corresponding screen.
- Step 2 Select the desired input source and set the corresponding parameter.

Source Type	Description
DP/HDMI/USB source	Supported options: <b>Embedded, Audio In</b>
SDI source	Supported options: <b>None, Audio In</b>

### 5.11.4 Low Latency

When the input source travels from where it comes to the processing device, sending device and then the receiving card, latency exists inevitably. Turning on this function can effectively help to reduce the latency from the input to output.

#### Notes

If you set the low latency mode to **Auto**, the system will determine whether to enable the low latency based on the screen topology. The specific rules are as follows.

- For a single Ethernet port with vertical cabling and no overlap in the Y direction, the low latency will be automatically enabled if all the following requirements are met; otherwise, it will be disabled.
  - The cabinets loaded by one Ethernet port cannot be overlapped, while blank configurations are allowed.

- The circumscribed rectangles of all cabinets loaded by Ethernet ports must be aligned at the top of the canvas.
- No need to keep the same cabinet size.

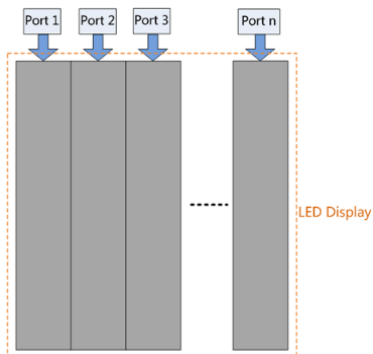

- For free topology, the low latency will be automatically enabled if all the following requirements are met; otherwise, it will be disabled.
  - The cabinets loaded by one Ethernet port cannot be overlapped, while blank configurations are not allowed.
  - The circumscribed rectangles of all cabinets loaded by Ethernet ports must be aligned at the top of the canvas. The size of the circumscribed rectangle cannot exceed 650,000 pixels.
  - The size of all cabinets must be the same.

## Operating Procedure

On the main menu screen, go to **Advanced Settings > Low Latency** and press the knob to confirm. Then, rotate the knob to select **On**, **Off** or **Auto** as needed.

- Off: Turn off the function. (Default option)
- On: Turn on the function. The device latency can be reduced by 1 frame.

### Note

After you manually enable the low latency function, it is advisable to align the circumscribed rectangle loaded by each Ethernet port at the top of the canvas. If not aligned, the loading capacity will be reduced. For calculating the actual loading capacity, please refer to [Loading Capacity Calculation Method in Low Latency Mode](#).

- Auto: If you set the low latency mode to **Auto**, the system will determine whether to enable the low latency based on the screen topology. If the wiring meets the rules, low latency will be enabled automatically; otherwise, it will be disabled automatically. For specific rules, please refer to the notes in this section.

## 5.11.5 HDR

HDR is the abbreviation for High-Dynamic Range. HDR function can greatly enhance the display image quality, allowing for a more clear and vivid image when the device is used together with the specified receiving cards.

### Note

Only the VX2000 Pro supports the HDR function.

### 5.11.5.1 HDR Source Settings

Set the related parameters of an HDR source.

#### Prerequisites

- Use the layer 1 source as an HDR source.
- An HDR source (HDR10/HLG standard) must be used to realize optimal HDR effect.

#### Notes

- An HDR source can be connected to the HDMI 2.0 or 12G-SDI connector only.
- The HDR and 3D functions cannot be used together.
- Using the HDR function paired with receiving cards of different models will reduce the device loading capacity by half or quarter because the HDR input source is 10-bit. Please work out a connection solution in advance.

#### Screen Example

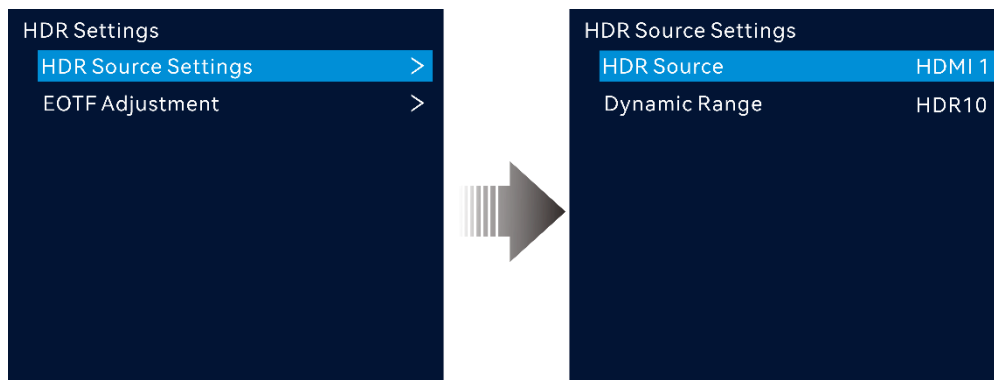

## Operating Procedure

- Step 1 On the main menu screen, go to **Advanced Settings > HDR Settings > HDR Source Settings** to enter the HDR source settings screen.
- Step 2 Rotate the knob to select **HDR Source** and press the knob to expand the HDR source list.
- Step 3 Rotate the knob to select the target HDR source and press the knob to confirm.
- Step 4 Set the dynamic range of the HDR source.

Figure 5-19 HDR effect



## Parameter Descriptions

Menu	Description
HDR Source	You can select an HDR source connector through the HDMI 2.0 or 12G-SDI connector.
Dynamic range	The dynamic range of an HDR source The supported options include <b>HDR10</b> , <b>HLG</b> , <b>off</b> and <b>From Input</b> .

### Note

When you enable the HDR function, the receiving card supporting this function should be used together. For the specified receiving card model and related information, please refer to our official website ( ).

### 5.11.5.2 Adjust EOTF

EOTF is the abbreviation for Electro-Optical Transfer Function. It allows for precise tuning of the electro-optical conversion characteristics of a signal source, significantly improving the overall brightness performance, details of the darkest areas, clarity of the highlight areas and

final contrast effect. Additionally, adjusting images based on different ambient light conditions is also supported to achieve a more desirable viewing experience.

## Notes

The supported adjustment parameters depend on the HDR source settings.

## Screen Example

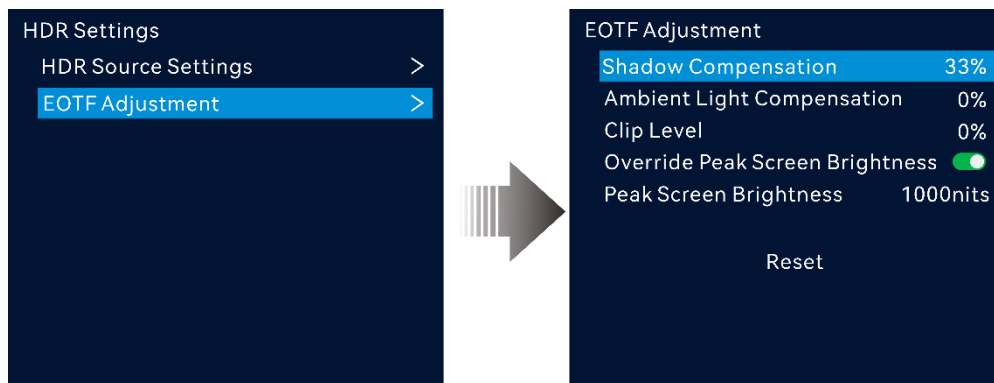

## Parameter Descriptions

Parameter	Description
Shadow Compensation	Adjust this parameter to enhance the image display effect. The greater the value, the clearer the details in the shadow area. Range: 0 to 100 (default: 33), Step: 1
Ambient Light Compensation	Adjust this parameter to reduce the loss of image details caused by ambient light diffusion. Range: 0 (default) to 80 , Step: 1
Clip Level	Adjust the parameter to reduce the screen overexposure and enhance details of the highlight areas. Range: 0 (default) to 100 , Step: 1
Override Peak Screen Brightness	Turn on or turn off the function. <ul style="list-style-type: none"> <li>On: <input checked="" type="checkbox"/></li> <li>Off: <input type="checkbox"/></li> </ul>
Peak Screen Brightness	Adjust the brightness of the screen when it is functioning normally. When <b>Override Peak Screen Brightness</b> is enabled, this parameter can be adjusted. Range: 100 to 10000 nits (default: 1000 nits), Step: 1

## 5.11.6 3D Settings

Directly connect a third-party 3D emitter using the device's built-in 3D connector, or connect to the EMT200 Pro emitter via the device's Ethernet port. Then, use the compatible 3D glasses to achieve a 3D display effect.

### Prerequisites

- Video source format: Side-by-side, top-and-bottom or frame sequential
- When paired with the EMT200 Pro, it is recommended to use a 3D source of 60Hz to enjoy an optimal experience.

### Notes

- When the 3D function is enabled and the video source format is **Side-by-Side** or **Top-and-Bottom**, the device output capacity will be halved.
- When the 3D function is enabled and the video source format is **Frame Sequential**, you need to manually set the output frame rate which must be the same as the input frame rate.
- The 3D effect follows the layer. The output area where a 3D layer is located always displays the 3D effect.
- The 3D function and input cropping cannot be enabled at the same time.

### Hardware Connections

The diagram takes the VX2000 Pro as an example.

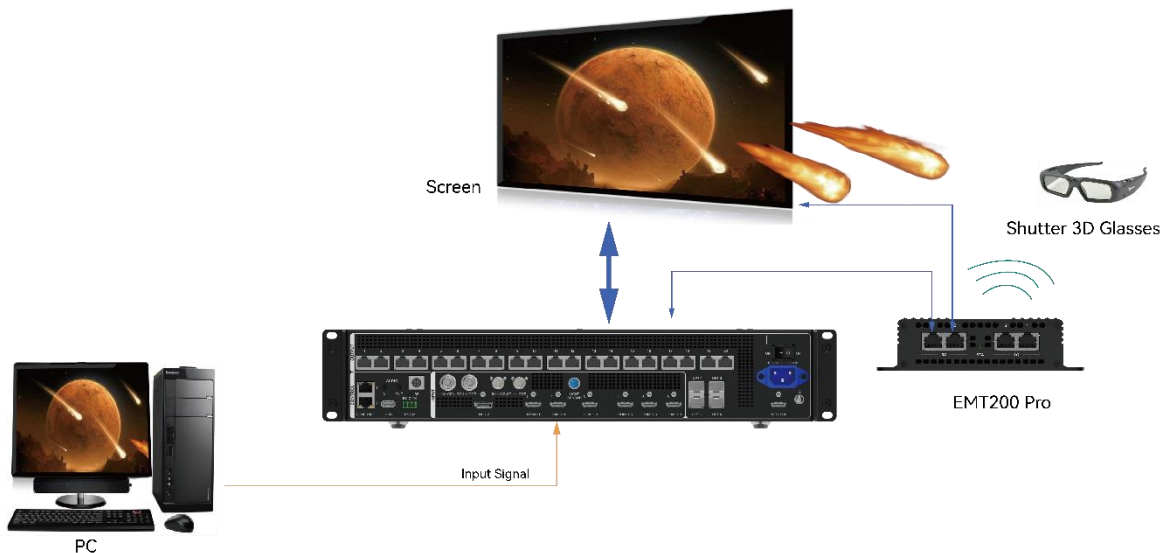

## Screen Example

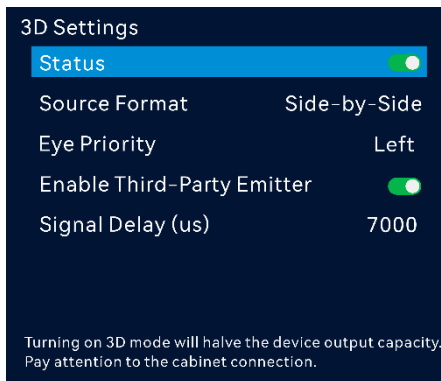

## Operating Procedure

- Step 1 On the main menu screen, go to **Advanced Settings > 3D Settings > Status** to turn on the function.
- Step 2 Select the 3D format of the video source. The options include **Side-by-Side**, **Top-and-Bottom** and **Frame Sequential**.
- Step 3 Set the eye priority. The options include **Left** and **Right**.
- Step 4 (Optional) Turn on the **Enable Third-Party Emitter** switch.
- Step 5 Set the signal delay duration.

The value ranges from 0 to 20000 and defaults to 7000. (Step: 1, unit: us)

### 5.11.7 Standby Mode

Enabling standby mode can effectively reduce energy consumption caused by screen heat generation.

## Parameter Descriptions

Parameter	Description
Standby Mode	<p>Turn on or turn off this function.</p> <ul style="list-style-type: none"> <li>• : On</li> </ul> <p>Once the standby mode is enabled, the output image will go black and the output volume will be adjusted to 0. The device LCD screen will also be locked, while other parameters remain unchanged.</p>

Parameter	Description
	<ul style="list-style-type: none"> <li>• : Off</li> </ul>

### 5.11.8 HDCP Status

High-bandwidth Digital Content Protection (HDCP) is a form of digital copy protection to prevent copying of digital audio and video content as it travels across connections. When the accessed input source is an HDCP-encrypted one, you need to turn on this function to enable the device to transmit and process the source.

#### Parameter Descriptions

Parameter	Description
HDCP Status	Turn on or off HDCP function for the input source.

### 5.11.9 Monitor Settings

Real-time display of the output image via the monitor connected is supported. You can monitor whether the output is normal and adjust the display ratio of the monitoring image on the monitor to avoid image distortion.

#### Parameter Descriptions

Parameter	Description
Scaling Mode	<p>The options include <b>Keep Ratio</b> and <b>Full Screen</b> (default).</p> <ul style="list-style-type: none"> <li>• Keep Ratio: Keep the ratio of the original output image to display.</li> <li>• Full Screen: Display the output image in full screen.</li> </ul> <p> <b>Note</b></p> <p>When <b>Keep Ratio</b> is selected, the blank area that the output image cannot cover the entire monitor screen will be automatically filled with solid black.</p>
Definition	<p>The supported options include <b>Smooth</b> and <b>High-Definition</b>.</p> <ul style="list-style-type: none"> <li>• Smooth: The monitoring image definition is 1920×1080@60Hz.</li> <li>• High-Definition: The monitoring image definition is 3840×2160@60Hz.</li> </ul>

## 5.12 System Settings

### 5.12.1 Fn

This function allows you to set a shortcut button for an assigned function. By using the Fn button, you can quickly navigate to the target menu screen and never need to access a specified menu item by entering the menus level by level.

#### Screen Example

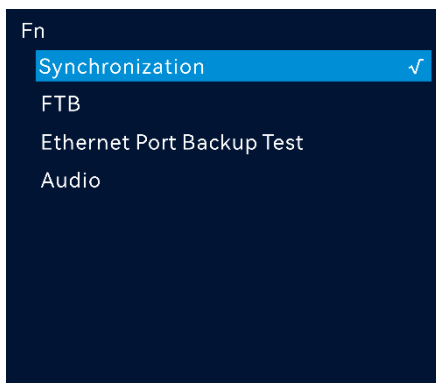

#### Operating Procedure

- Step 1 On the main menu screen, go to **System Settings** > **Fn** press the knob to enter the Fn button settings screen.
- Step 2 Rotate the knob to select the desired function and press the knob to confirm.

### 5.12.2 Return to Home

#### Operating Procedure

- Step 1 On the main menu screen, go to **System Settings** > **Return to Home** and press the knob to confirm.
- Step 2 Rotate the knob to select the desired time value and press the knob to confirm.

## Parameter Descriptions

Parameter	Description
Return to Home	<p>You can set the period when the system stays at the current screen before returning to the homepage automatically when there is no operation performed.</p> <p>The value ranges from 60s to 3600s</p>

### 5.12.3 Diagnostics

The diagnostics function helps you to diagnose the system and troubleshoot the malfunctioned device components. When the device fails, you can run the diagnostics function to test the device. You can send your test to our technical support staff for problem locating and processing. For daily maintenance, you can run the diagnostics function to do the routine health check for the system.

#### Notes

Running diagnostics will transiently disrupt the output, and the output will resume after the diagnostics are completed.

### Operating Procedure

- Step 1 On the main menu screen, go to **System Settings > Diagnostics** and press the knob to enter the diagnostics screen.
- Step 2 Rotate the knob to select **Run Diagnostics** and press the knob to confirm,
- Step 3 In the popup dialog, rotate the knob and select **Yes** and press the knob to confirm.

### 5.12.4 Export Logs

Export the device logs to a USB drive to quickly identify issues.

#### Prerequisites

Before exporting logs, you have inserted a USB drive into the USB port on the device.

## Operating Procedure

- Step 1 On the main menu screen, go to **System Settings > Log Export** to enter the log exporting screen.
- Step 2 Rotate the knob to select **Apply** and press the knob to confirm. The log file will be exported to the root directory of the USB drive.

## 5.12.5 Update Device

Import the update file saved in a USB drive to the device for quick update.

### Prerequisites

- Before updating the device, you need to decompress the firmware package and copy the update file (.img) to the root directory of a USB drive. The supported USB drive formats include NTFS, FAT32, and exFAT. It is recommended to use a USB drive in FAT32 format.
- Before updating the device, you need to insert a USB drive with the update file into the USB 2.0 port on the device rear panel.

### Notes

- During the update process, power-off and all operations are NOT allowed.
- Additionally, you can update the device via Unico or NovaLCT. For detailed operations, please refer to [Maintain Devices](#) or NovaLCT user manual respectively.

### Screen Example

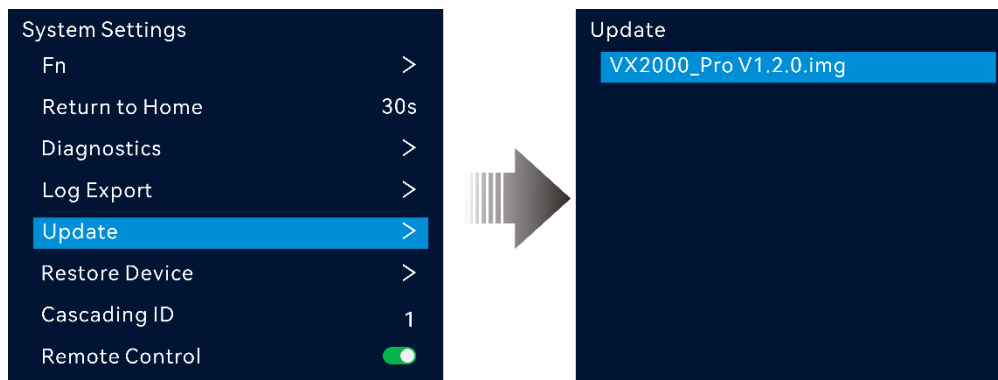

## Operating Procedure

- Step 1 On the main menu screen, go to **System Settings > Update** to enter the device update screen.
- Step 2 Rotate the knob to select the update file and press the knob to confirm.
- Step 3 In the popup dialog box, rotate the knob to select **OK** and press the knob to confirm. Then wait for the device to automatically complete the update.

### 5.12.6 Restore Devices

Each restore point is a snapshot of the device configuration at a specific moment. If something unexpected occurs, simply select a restore point to quickly revert the device configuration to the state it was in at the time the restore point was created.

#### Prerequisites

None

#### Notes

Up to 5 restore points can be created (total capacity limit: 1GB).

#### Screen Example

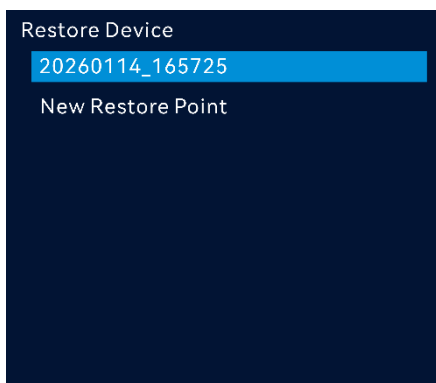

#### Operating Procedure

- Step 1 On the main menu screen, go to **System Settings > Restore Device** to enter the device restoration screen.

Step 2 Perform the following operations as needed.

- Add the restore point: Rotate the knob to select **New Restore Point** and press the knob to confirm.

The prefix for the name of the new restore point is the date when the operation is performed.

- Restore the device: Rotate the knob to select the target restore point and press the knob to confirm. In the popup dialog box, select **Restore** and press the knob to confirm.
- Delete the restore point: Rotate the knob to select the target restore point and press the knob to confirm. In the popup dialog box, select **Delete** and press the knob to confirm.

## 5.12.7 Cascading ID

Set the device cascading ID which is the unique identification when the device is in a cascading link.

### Notes

- The cascading ID defaults to **1** and can be changed manually. You need to set an ID for each cascading device in order.
- After you set IDs successfully, connect devices using Ethernet cables based on the set ID.

### Parameters Description

Parameter	Description
Cascading ID	When multiple devices are cascaded, you need to set a virtual ID for each device, ensuring that the devices displayed in NovaLCT match with actual devices.

## 5.12.8 Remote Control

Enable or disable the remote control.

### Prerequisites

- Insert the matching Bluetooth module into the USB 2.0 port on the device rear panel.

- The remote control and the device have been successfully paired. For the pairing method, please refer to [Button Descriptions](#)
- The resolution of the loaded LED screen must be greater than 800×600.

## Notes

- The remote control is an optional accessory and must be purchased separately.
- Effective operating distance of remote control: within 10 meters from the device

## Screen Example

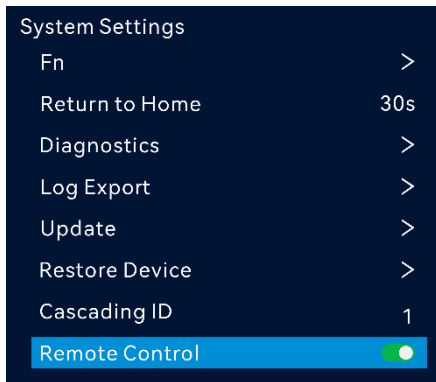

## Parameter Descriptions

Parameter	Description
Remote Control	Turn on or turn off the function. <ul style="list-style-type: none"> <li>• On: </li> <li>• Off: </li> </ul>

## 5.13 Factory Reset

Factory reset function allows you to reset all the parameter settings of the device to factory defaults after the device update or when you think the parameters are improperly set.

## Screen Example

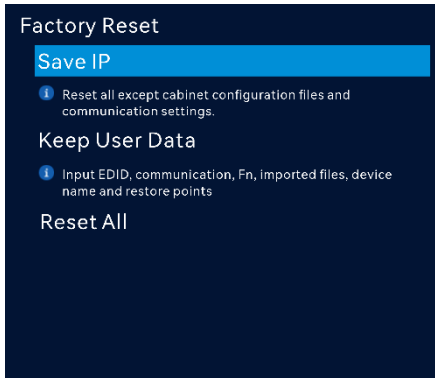

## Parameter Descriptions

Parameter	Description
Save IP	Reset the parameter settings to factory defaults, except for the configuration file and communication parameter settings.
Keep User Data	Reset the parameter settings to factory defaults, except for the input EDID, communication parameter settings, Fn, imported files and device name and restore points.
Reset All	Reset all the parameter settings to factory defaults.

## 5.14 Communication Settings

You can set the communication and network information to enable the device to communicate with the control PC smoothly.

## Screen Example

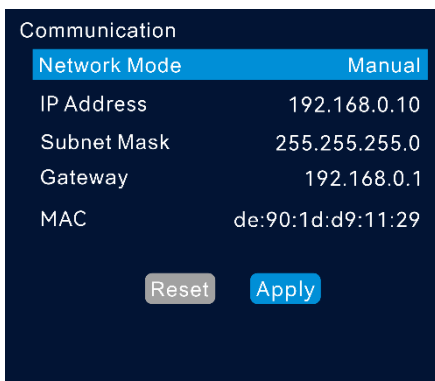

## Operating Procedure

Step 1 On the main menu screen, rotate the knob to select **Communication** and press the knob to enter the communication settings screen.

Step 2 Select **Network Mode** and press the knob to confirm.

The options include **Manual** and **Automatic**.

- Manual: Set the device IP address, subnet mask and gateway manually.
- Automatic: The system automatically assigns an IP address for the device. When the device and control PC are connected to the same router or switch, set this option to **Automatic**.

Step 3 When the **Manual** option is selected, you must manually set the device IP address, subnet mask and gateway.

Step 4 Rotate the knob to select **Apply** to make the settings take effect; otherwise, select Reset to reset the settings to defaults.

### Note

Rotate the knob to **Reset** and press the knob to confirm, and then all network parameters will be reset to defaults.

## 5.15 Device Working Mode

Three working modes are supported, including **Video Controller**, **Fiber Converter** and **ByPass**.

### Screen Example

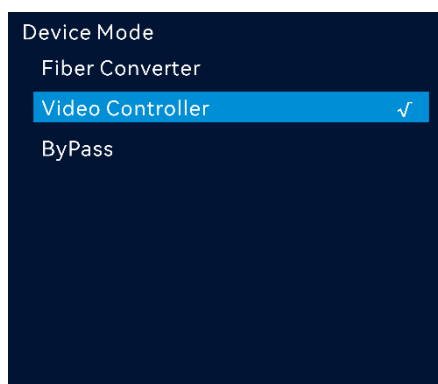

## Parameter Descriptions

Table 5-4 Fiber converter

Device Model	Description
VX400 Pro	<p>Optical fiber ports are used for input, and Ethernet ports are used for output.</p> <ul style="list-style-type: none"> <li>• OPT 1~2 are used for input, and Ethernet ports are used for output.</li> <li>• OPT 1 serves as the primary connectors. The Ethernet ports 1~4 transmit OPT 1 data.</li> <li>• OPT 2 serves as the backup connectors.</li> </ul>
VX600 Pro	<p>Optical fiber ports are used for input, and Ethernet ports are used for output.</p> <ul style="list-style-type: none"> <li>• OPT 1~2 are used for input, and Ethernet ports are used for output.</li> <li>• OPT 1 serves as the primary connectors. The Ethernet ports 1~6 transmit OPT 1 data.</li> <li>• OPT 2 serves as the backup connectors.</li> </ul>
VX1000 Pro	<p>Optical fiber ports are used for input, and Ethernet ports are used for output.</p> <ul style="list-style-type: none"> <li>• OPT 1~2 are used for input, and Ethernet ports are used for output.</li> <li>• OPT 1 serves as the primary connectors. The Ethernet ports 1~10 transmit OPT 1 data.</li> <li>• OPT 2 serves as the backup connectors.</li> </ul>
VX2000 Pro	<p>Optical fiber ports are used for input, and Ethernet ports are used for output.</p> <ul style="list-style-type: none"> <li>• OPT 1~4 are used for input, and Ethernet ports are used for output.</li> <li>• OPT 1 and OPT 2 serve as the primary connectors. The Ethernet ports 1~10 transmit OPT 1 data, and Ethernet ports 11~20 transmit OPT 2 data.</li> <li>• OPT 3 and OPT 4 serve as the backup connectors.</li> </ul>

Table 5-5 Video controller

Device Model	Description
VX400 Pro	<ul style="list-style-type: none"> <li>• OPT 1 can be used as an input or output connector depending on the connected devices.</li> <li>• OPT 1 sends the output on Ethernet ports 1~4. OPT 2 copies or backs up the output on Ethernet ports 1~4.</li> </ul>
VX600 Pro	<ul style="list-style-type: none"> <li>• OPT 1 can be used as an input or output connector depending on the connected devices.</li> </ul>

Device Model	Description
	<ul style="list-style-type: none"> <li>• OPT 1 sends the output on Ethernet ports 1~6. OPT 2 copies or backs up the output on Ethernet ports 1~6.</li> </ul>
VX1000 Pro	<ul style="list-style-type: none"> <li>• OPT 1 can be used as an input or output connector depending on the connected devices.</li> <li>• OPT 1 sends the output on Ethernet ports 1~10. OPT 2 copies or backs up the output on Ethernet ports 1~10.</li> </ul>
VX2000 Pro	<ul style="list-style-type: none"> <li>• OPT 1 and OPT 2 can be used as an input or output connector depending on the connected devices.</li> <li>• OPT 1 and OPT 2 send the output on Ethernet ports 1~10 and 11~20 respectively. OPT 3 and OPT 4 copy or back up the output on Ethernet ports 1~10 and 11~20 respectively.</li> </ul>

Table 5-6 ByPass

Device Model	Description
VX400 Pro/VX600 Pro/VX1000 Pro/VX2000 Pro	Under this mode, the device works as an independent controller with no support for video processing functions.

## 5.16 OPT Mode

Supports settings of both the OPT working mode and loop mode.

### Screen Example

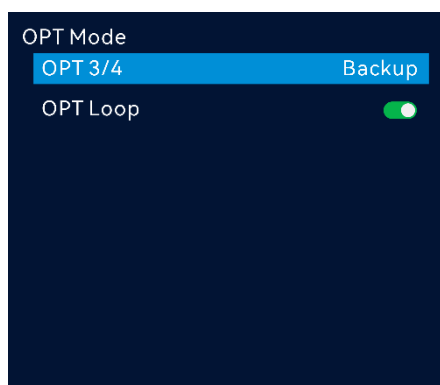

### Hardware Connections

The diagram takes the VX2000 Pro as an example.

Figure 5-20 Copy mode

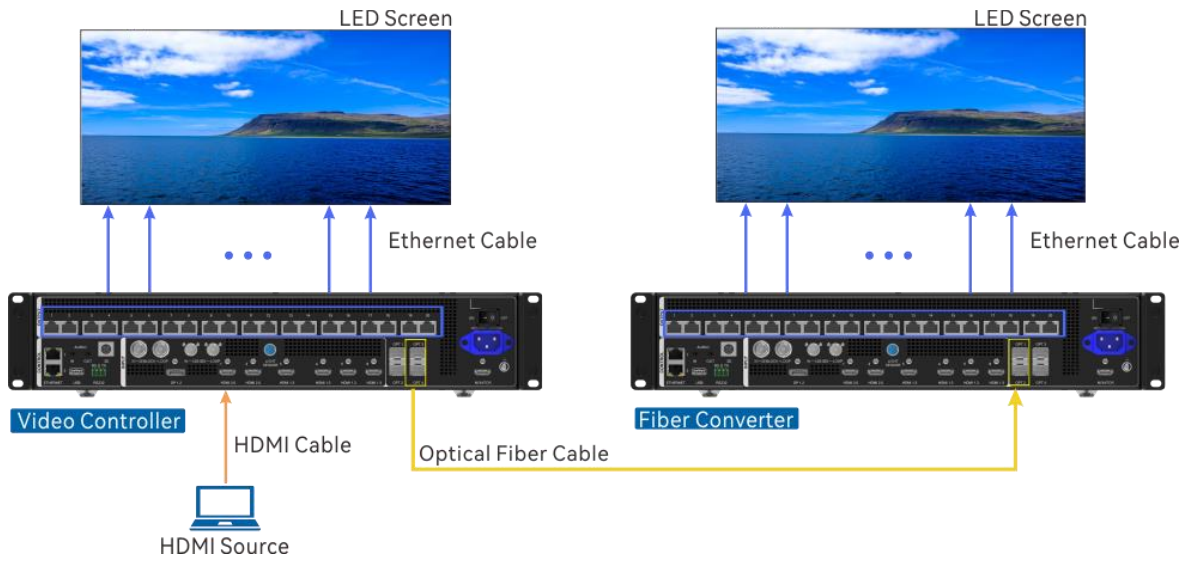

Figure 5-21 Backup between Ethernet and OPT ports

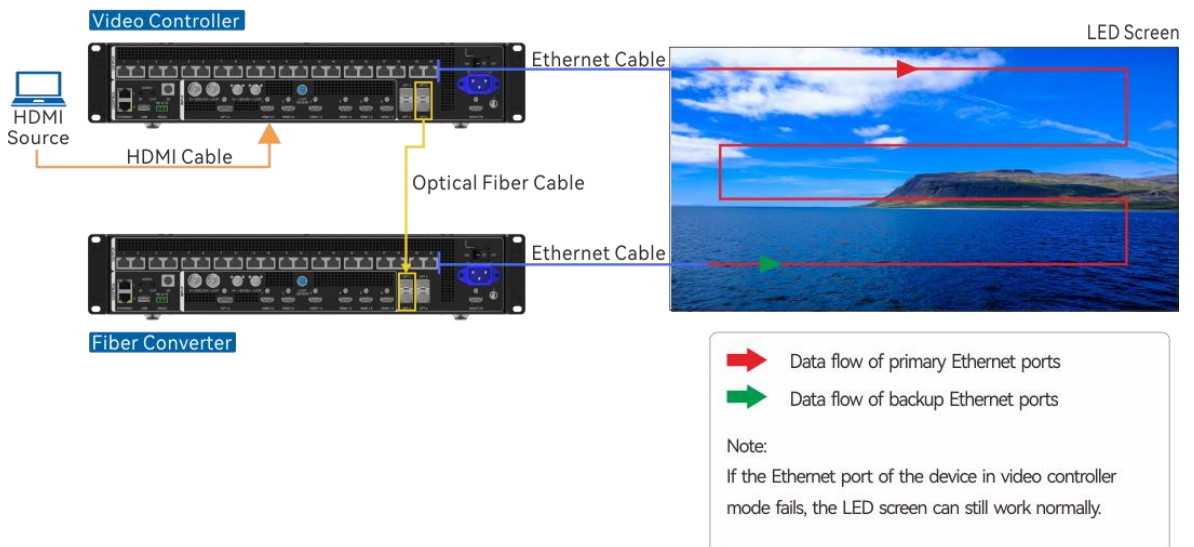
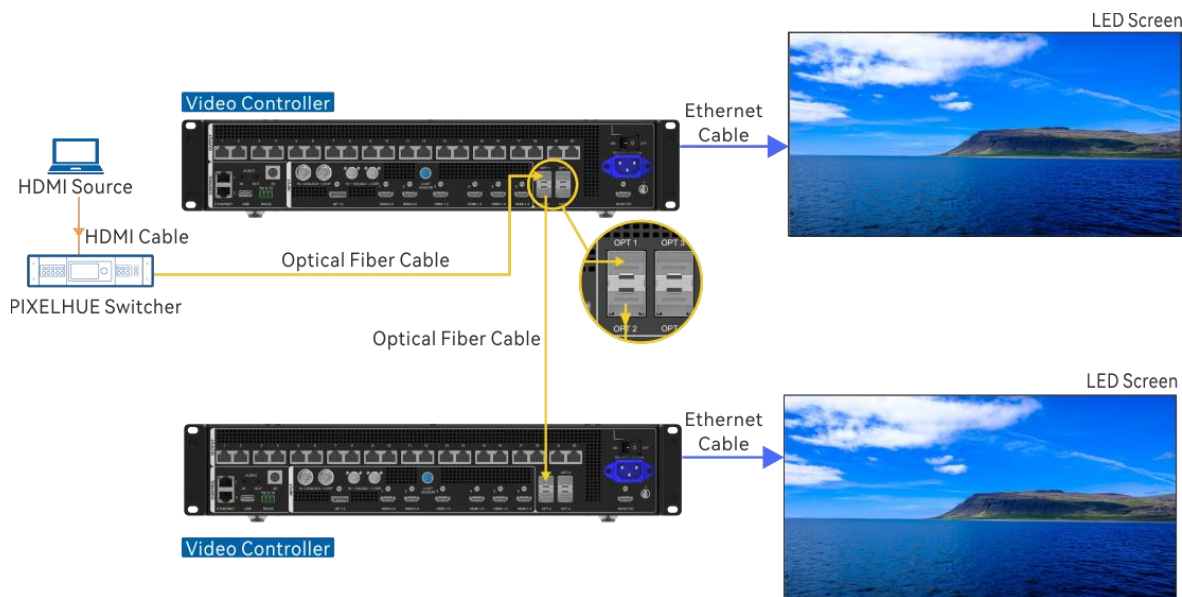

Figure 5-22 OPT loop mode



## Parameter Descriptions

Table 5-7 OPT working mode

Device Model	Parameter	Description
VX400 Pro	OPT 2	<ul style="list-style-type: none"> <li>• Copy: OPT 2 copies the output on Ethernet ports 1~4.</li> <li>• Backup: OPT 2 backs up the output on Ethernet ports 1~4.</li> </ul>
VX600 Pro		<ul style="list-style-type: none"> <li>• Copy: OPT 2 copies the output on Ethernet ports 1~6.</li> <li>• Backup: OPT 2 backs up the output on Ethernet ports 1~6.</li> </ul>
VX1000 Pro		<ul style="list-style-type: none"> <li>• Copy: OPT 2 copies the output on Ethernet ports 1~10.</li> <li>• Backup: OPT 2 backs up the output on Ethernet ports 1~10.</li> </ul>
VX2000 Pro	OPT 3/4	<ul style="list-style-type: none"> <li>• Copy: OPT 3 copies the output on Ethernet ports 1~10, and OPT 4 copies the output on Ethernet ports 11~20.</li> <li>• Backup: OPT 3 backs up the output on Ethernet ports 1~10, and OPT 4 backs up the output on Ethernet ports 11~20.</li> </ul>

Table 5-8 OPT loop mode

Device Model	Parameter	Description
VX400 Pro/VX600 Pro/VX1000 Pro/VX2000 Pro	OPT Loop	Loop out the video signal accessed by OPT 1 via OPT 2 for device mosaic. <ul style="list-style-type: none"> <li>• <input checked="" type="checkbox"/>: Enable the loop mode.</li> </ul>

Device Model	Parameter	Description
		<ul style="list-style-type: none"> <li><input type="checkbox"/>: Disable the loop mode.</li> </ul>

## 5.17 About Us

Under this menu item, you can view the firmware version, device SN, official website and email address. On our official website, you can check the latest device information and the updates for this device. You can also send your feedback or suggestion to us for improvements via the supplied email address.

### Screen Example



## 5.18 Language

The language options include English, Simplified Chinese, Traditional Chinese, Hindi, Spanish, French, Portuguese, Russian, Japanese, Korean, German, Vietnamese, Turkish, Thai and Indonesian. You can switch to your preferred language.

# 6 Remote Control

Enable or disable the device standby mode, power on or power off the screen, adjust the screen brightness and output volume, switch presets, set the USB playback parameters, adjust the output image quality, switch layer input sources and set the 3D function through a remote control.

## 6.1 Button Descriptions

Figure 6-1 Remote control

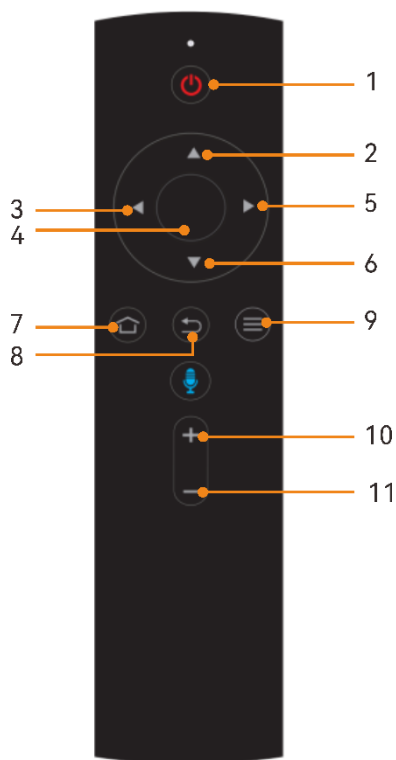

Table 6-1 Button descriptions

No.	Description
1	<ul style="list-style-type: none"> <li>• Enable or disable the standby mode.</li> <li>• Connect a multifunction card and press this button to power on or power off the screen.</li> </ul>
2, 6	<p>Press the button to adjust the brightness by step, and hold down the button for quick adjustment. Range: 0% to 100%, Step: 1</p> <p>On the menu interface, the button can be used as the up/down button.</p>

No.	Description
3, 5	Play the previous or next USB media file. On the menu interface, the button can be used as the left/right button.
4	Press the button to play the current USB media file or stop the playback.
7	Press the button to enter the <b>Settings</b> interface.
8	Return or exit button.
9	Press the button to enter the preset switching menu.
10	Press the button to increase the output volume.
11	Press the button to decrease the output volume.

 Note

Insert the matching Bluetooth module into the USB 2.0 port on the device rear panel, and then simultaneously hold down the "6" and "8" buttons until the remote control's red light illuminates, so that the remote control is successfully paired with the device.

## 6.2 OSD Menu Descriptions

Figure 6-2 All settings



## Switch Presets

Figure 6-3 Interface example



Press the direction button to select the desired preset. After selection, press the OK button to load the selected preset.

## Switch Layer Input Sources

Figure 6-4 Interface example

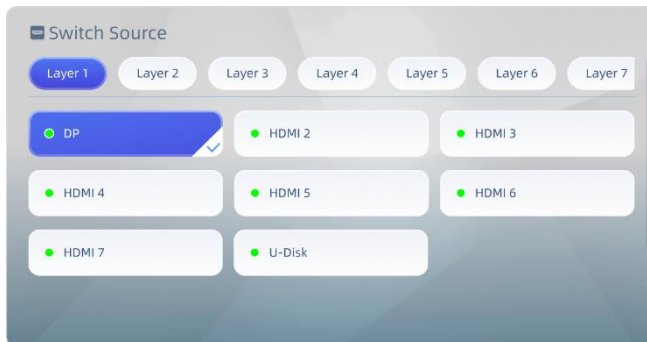

Press the direction button to select the desired layer and input source respectively. After selection, press the OK button to switch the input source of the selected layer.

## USB Playback

Figure 6-5 Interface example

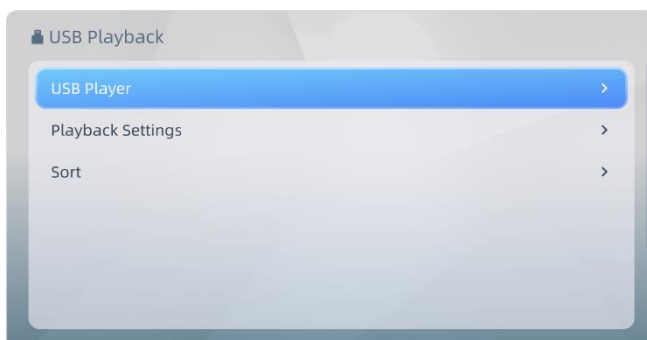

Table 6-2 Menu descriptions

Menu	Description
USB Player	Display the video and image file list. Press the up/down button to select the desired file, and then press the OK button to play the selected file.
Playback Settings	The supported parameters include <b>Playback Mode</b> , <b>File Type</b> , <b>Image Playback Duration (s)</b> , <b>Image Transition Effect</b> , <b>Image Trans Duration (s)</b> , <b>Auto Playback</b> and <b>Resume Playback</b> . For detailed information, please refer to <a href="#">Playback Settings</a> .
Sort	Select the desired media file, and then press the left/right button to adjust the sequence of the selected file displayed in the playback list.

## Adjust Image Quality

Figure 6-6 Screen example

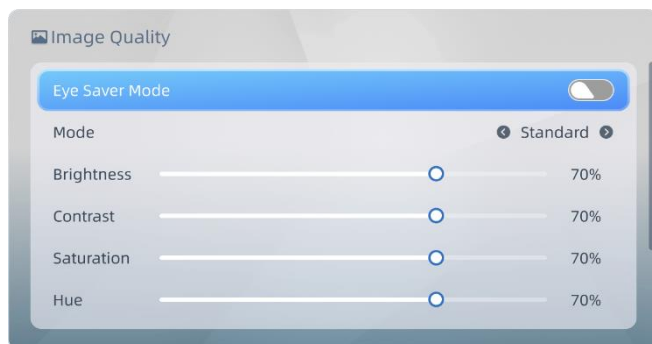

Table 6-3 Menu descriptions

Menu	Description
Eye Comfort Mode	Turn on or turn off this function. <ul style="list-style-type: none"> <li>On: </li> <li>Off: </li> </ul>
Mode	The display mode of the output image You can set the desired output mode based on the display content. The supported options include <b>Standard</b> (default), <b>Document</b> , <b>Conference</b> and <b>Video</b> . <div style="background-color: #f0f0f0; padding: 5px; margin: 5px 0;">  Note         </div> When the eye comfort mode is disabled, you can customize and reset the parameters of each mode.

Menu	Description
Brightness	Brightness is the shading of lights in the image.
Contrast	Contrast is the ratio of the luminance of the brightest color to that of the darkest color.
Saturation	Saturation is the colorfulness of the image. The higher the contrast, the more vivid the image.
Hue	The relative degree of how bright or dark the image is
Color Temperature	Adjust the cool or warm degree of images displayed on the LED screen.

## Adjust Brightness

Figure 6-7 Screen example

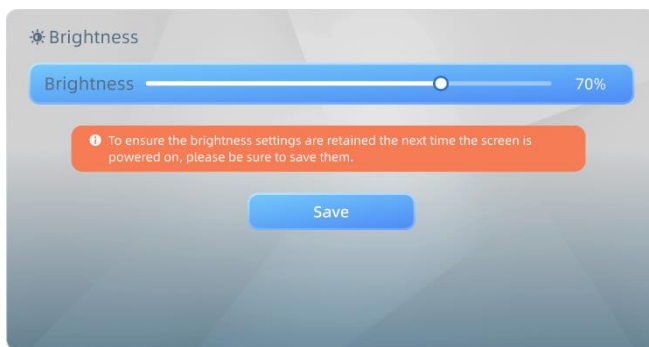

Press the left/right button to increase or decrease the screen brightness. After adjustments, press the direction button to select **Save** and press the OK button to automatically save the brightness parameter.

## 3D Settings

Figure 6-8 Screen example

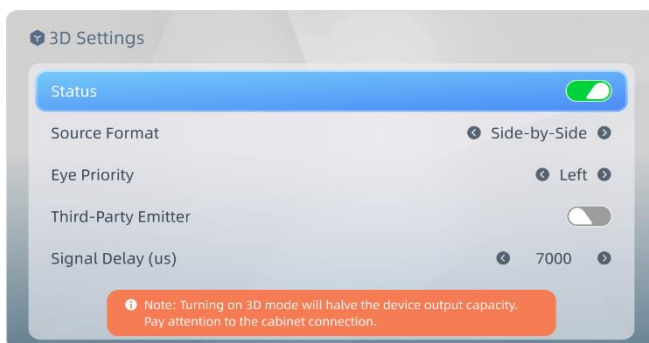





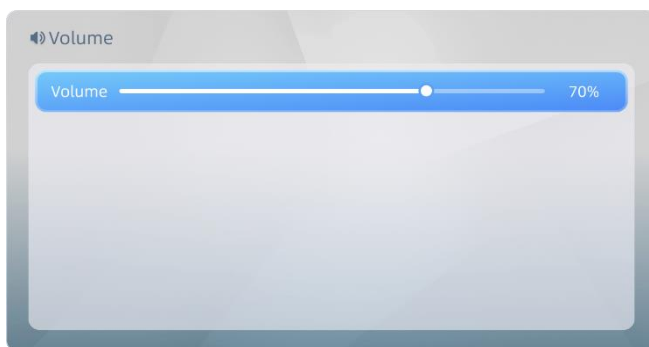

Table 6-4 Menu descriptions

Menu	Description
Status	<p>Turn on or turn off the switch.</p> <ul style="list-style-type: none"> <li>• On: </li> <li>• Off: </li> </ul>
Source Format	<p>The format of the 3D video source</p> <p>Set the format to <b>Side-by-Side</b>, <b>Top-and-Bottom</b> or <b>Frame Sequential</b> according to the format of the accessed video source.</p> <p> <b>Note</b></p> <p>When the 3D function is enabled and the video source format is <b>Side-by-Side</b> or <b>Top-and-Bottom</b>, the device output capacity will be halved.</p>
Eye Priority	<p>Set which image is sent first, the right eye image or the left eye image.</p> <p>Put on the 3D glasses to view the screen. If the display appears abnormal, adjust the parameter value to the other one. If the display is normal, no further adjustments are needed.</p>
Third-Party Emitter	<p>Turn on or turn off the function.</p> <ul style="list-style-type: none"> <li>• On: </li> <li>• Off: </li> </ul>
Emitter Delay	<p>Set the delay time of sending the synchronization signal from the 3D signal emitter to the 3D glasses. This setting ensures that the switching between left and right eye images of the 3D glasses is in sync with the switching between the left and right eye images on the screen. This parameter is applicable to both the NovaStar and third-party emitters.</p>

## Adjust Volume

Figure 6-9 Screen example



Press the left/right button to increase or decrease the volume.

# 7 Software Control

You can control the all-in-one video controller via both the Unico client software and webpage. Except for functions mentioned below, the other functions of the two operating terminals are the same. Here we take the operations on the client side as an example to illustrate.

Function Module	Unico Client	Unico Webpage
Cabinet library	Local pack, device pack	Device pack

## 7.1 Software Installation and Connection

### 7.1.1 Software Installation

#### Prerequisites

- The software package is obtained.
- A computer meeting the following requirements is prepared:

Windows:

- Operating system: Windows 10 (64-bit) or later
- CPU: 9th Generation Intel i7 processor or above
- Memory: 16 GB or above

Mac OS: Mac OS 10.14 or above

#### Installation Method

Run the .exe file and follow the setup wizard to complete the installation. If a firewall prompt appears, choose to allow the installation.

#### Installation Result

After a successful installation, the Unico software icon  is displayed on the desktop. Double-click this icon to open the Unico software.

## 7.1.2 Software Connection

The Unico software is installed on the control computer. The control computer can connect to the device in the following two ways:

- Via Ethernet cable

Connect the device and the control PC directly via Ethernet cable and set a static IP address for the device to let it and the control PC be on the same network segment.

- Via LAN

Connect the device and the control PC to the same LAN to ensure that both of them are on the same network segment.

## 7.2 Project Management

Create, edit and dissolve projects. Project files (.uprj) can be exported from the current device and imported into others, promptly applying device parameters and resource files.

### 7.2.1 Create New Projects

Devices of the same series on a local network are automatically added to a default project. Users can create additional projects and move online devices from the default project to new ones. Furthermore, simulation projects can be created to simulate real device configurations and understand the product better.

Step 1 Open the software and access the main interface.

Figure 7-1 Project

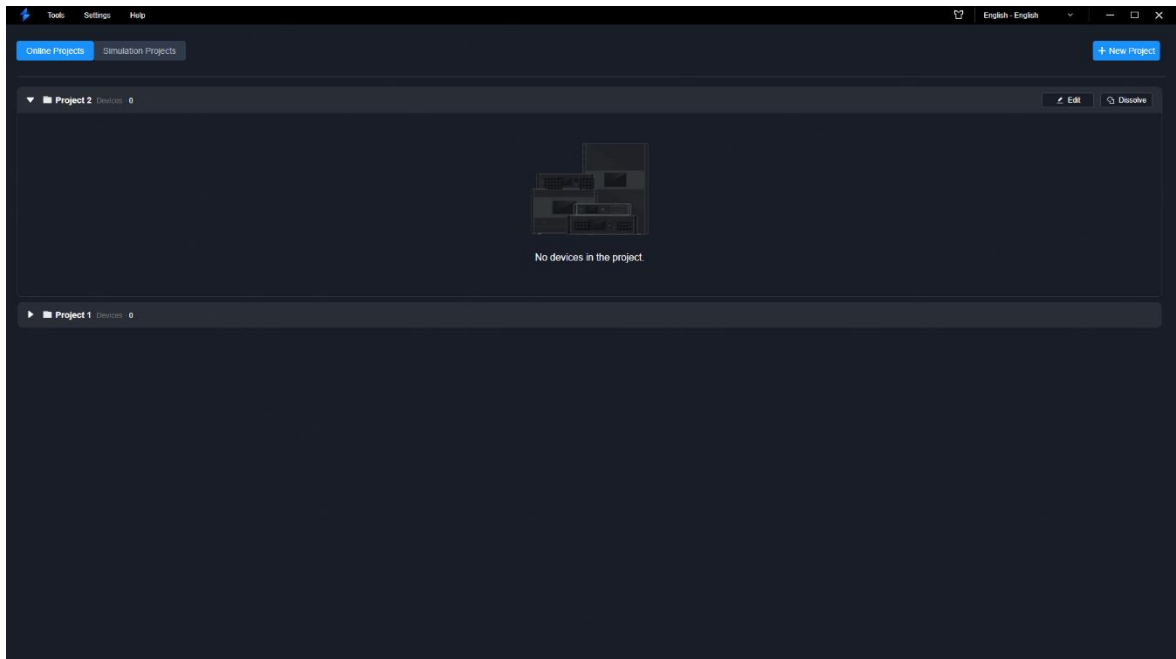

Step 2 Create an online project or simulation project.

- Online Project: Create a project for online devices. Select the **Online Project** tab at the top left and click **New Project** at the top right. Enter the project name in the popup window and click **OK**.

Figure 7-2 New projects

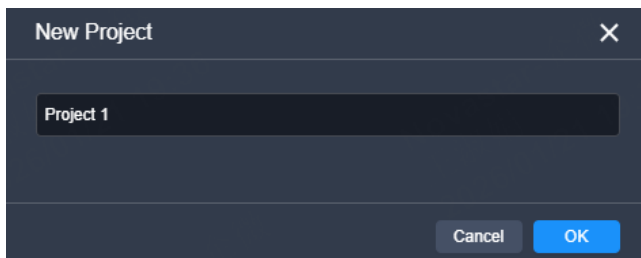

- Simulation Project: Create a project for simulation devices. Select the **Simulation Project** tab at the top left and click **New Project** at the top right. Enter the project name in the popup window and click **OK**.

After a simulation project is successfully created, please refer to [Simulation Devices](#) to add a simulation device.

For online projects, devices of the same series are automatically grouped under one project. When adding simulation devices, only devices of the same series can be included in a single project.

 **Note**

In the project list area, you can perform the project-related operations.

- Edit project: Click **Edit** to rename the project.
- Export project: Click **Export** to export the online project file. Simulation projects do not support exporting.
- Dissolve project: Click **Dissolve** to dissolve the current project. All online devices in the project will be moved to the default project.
- Enter project: Click **Enter** to enter the device configuration page.

### Step 3 Move devices between projects.

Expand the project list, hover over the target device, and click **Move** or manually drag it to another project.

- Move: Choose the target project in the popup window, then click **OK**.

Figure 7-3 Move devices

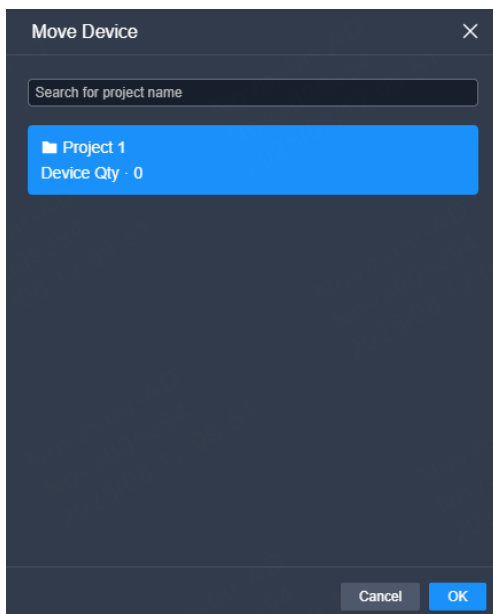

- Manual drag: Manually drag to another project and click **Yes** in the popup window.

#### Note

Devices of the same series can only be added into one project.

## 7.2.2 Import Projects

Import the local project files (.uprj) to the device. Please note that the device models must match with the models in the project file.

- Step 1 Select the **Online Projects** or **Simulation Projects** tab, and click **Enter** to access the device configuration interface.

Step 2 Navigate to **File > Import** from the menu bar.

Step 3 In the dialog box that appears, select a project file (.uprj) and click **OK**.



Step 4 In the displayed **Import Project File** window, select **Online Projects** or **Simulation Projects**.

Figure 7-4 Import project files

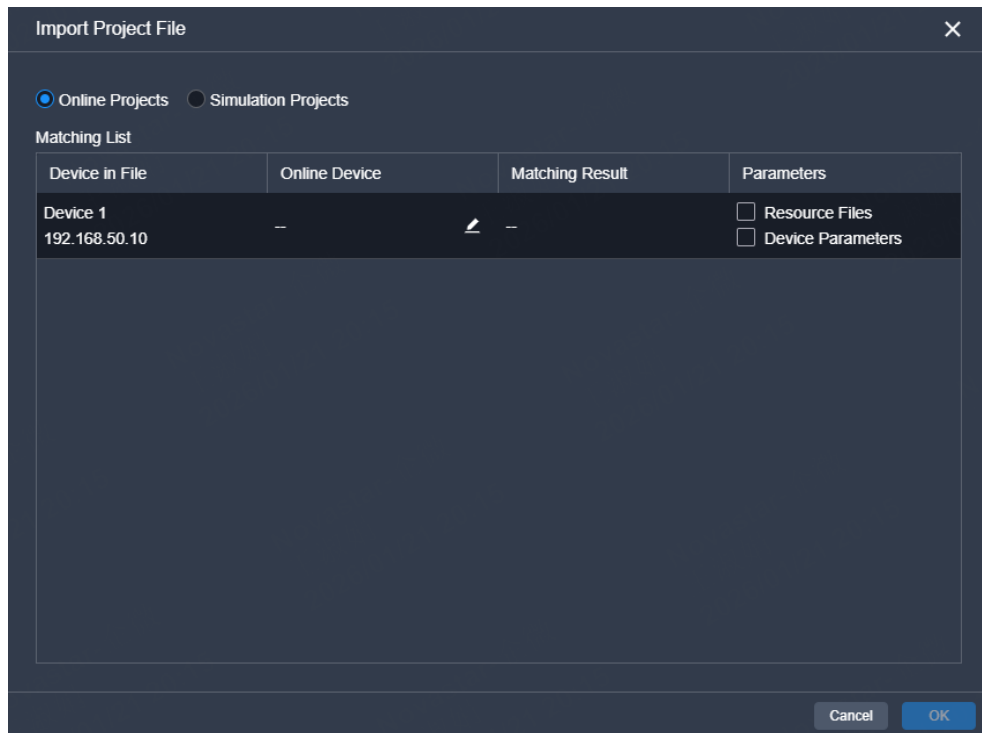

Step 5 After successful device matching, select the data to be imported and click **OK**.

The software matches the SN, name, IP address, model, and firmware version from the file with the online or simulation device. Click to modify the match:

- For online devices, select other online devices from the drop-down menu.
- For simulation devices, choose to create a new simulation device. Ignore the current device, or select another simulation device from the drop down menu.

### 7.2.3 Export Projects

Export the device project files to your local computer.

Step 1 Select the **Online Projects** or **Simulation Projects** tab, and click **Enter** to access the device configuration interface.

Step 2 In the menu bar, navigate to **File > Export**

Step 3 In the displayed dialog box, select the desired data.

Figure 7-5 Export project files

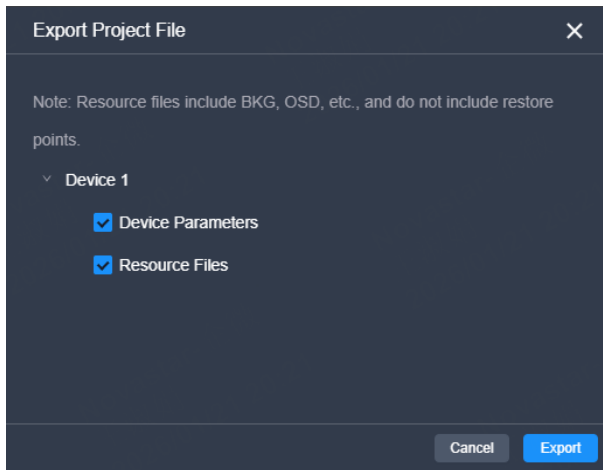

Step 4 Click **Export**.

Step 5 In the displayed dialog box, select a file path and click **Save**.

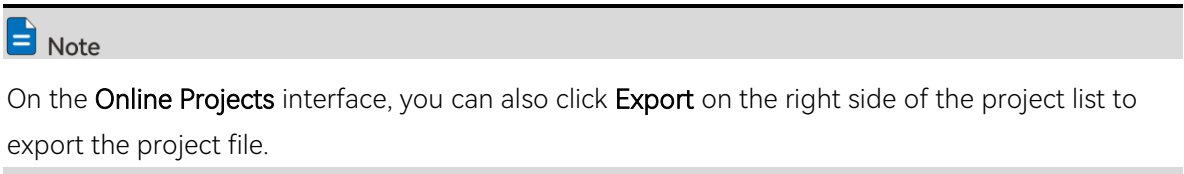

## 7.3 Device Management

### 7.3.1 Enter Device Configuration Page

#### 7.3.1.1 Online Devices

Step 1 Select the **Online Projects** tab.

Figure 7-6 Online project list (VX2000 Pro)

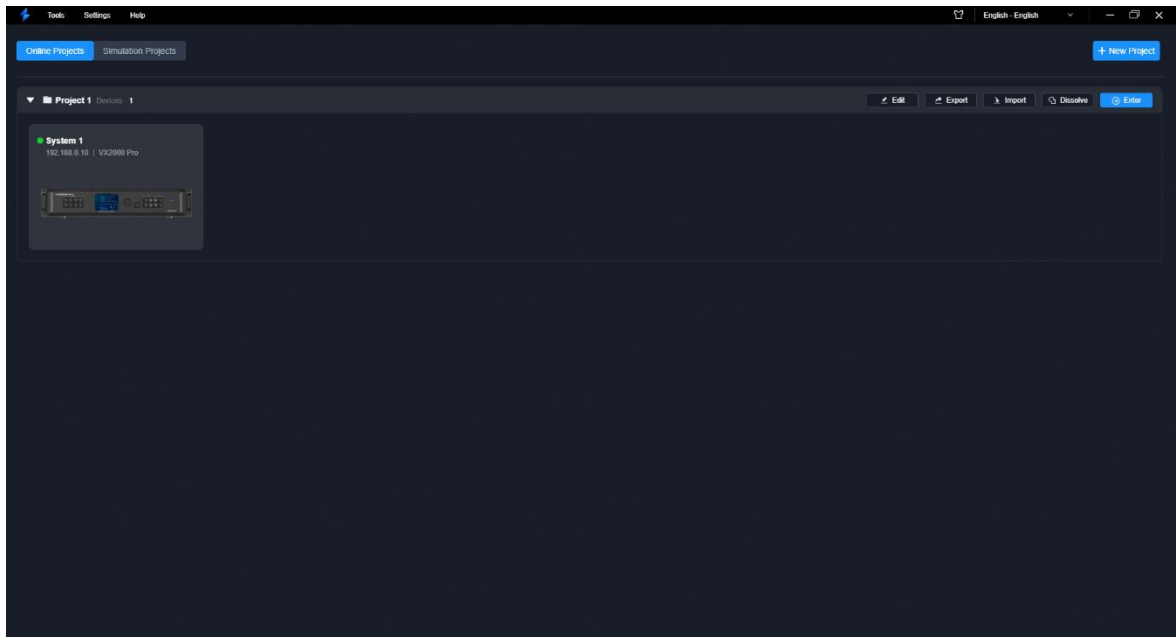

Step 2 Double click the device front panel image or click **Enter** on the right side of the project list to access the device configuration interface.

### 7.3.1.2 Simulation Devices

Simulation devices, without any physical connections, simulate real device configurations, enabling users to easily utilize and understand the software.

Step 1 Select the **Simulation Projects** tab.

Step 2 Click **Add simulation devices**.

#### Note

The device models supporting the simulation device function include the VX400 Pro and VX2000 Pro.

Step 3 In the pop-up dialog box, set the device name, model, and IP address, and click **OK**.

Once created, the device will be displayed in the list and will be in the default started state.



- : The device is started.
- : The device is off.

Figure 7-7 New simulation devices (VX2000 Pro)



**Note**

For devices in the project list, you can perform the following operations:

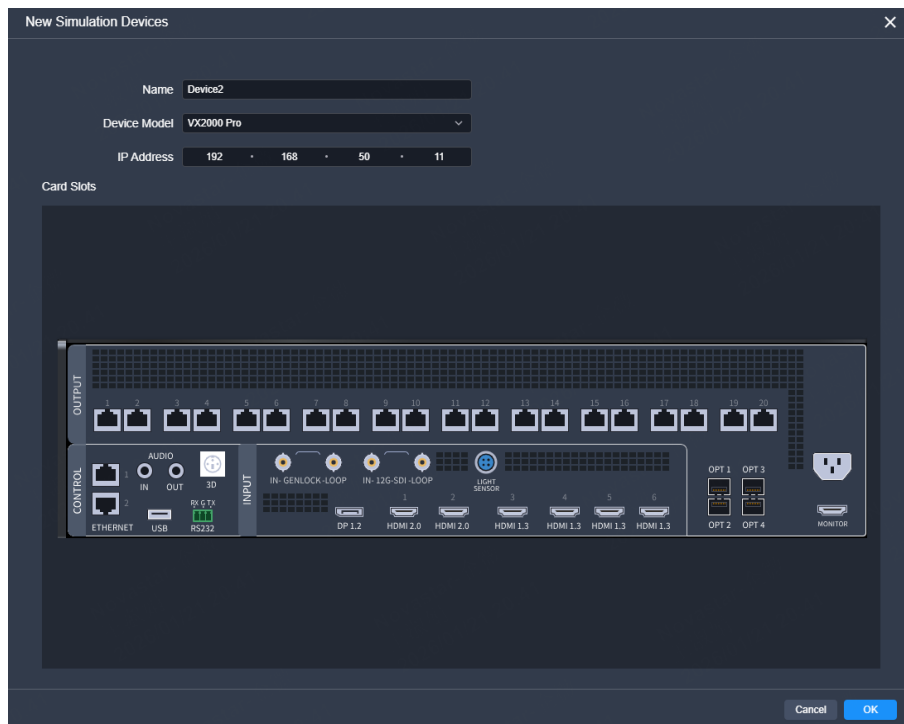
- Start all devices: Click **Start All**.
- Shut down all devices: Click **Shut Down All**.
- Shut down device: Click **Shut Down**.
- Start device: Click **Start**.
- Edit device: Click **Edit**.
- Move device: For an active device, click **Move**, choose the target project in the popup window, and click **OK**.
- Delete device: Click **Delete**.

**Step 4** After creation, you can view the device status, name, IP address, and model.

- Double click the device front panel image or click **Enter** on the right side of the project list to access the device configuration interface.
- Hover over the device information to start, shut down, edit (modify device name, IP address), move, or delete the device.



## 7.3.2 Configure Device Properties

Select the device on the left side of the device configuration interface, and then configure the device-related properties on the right pane.

Figure 7-8 Device properties (VX2000 Pro)

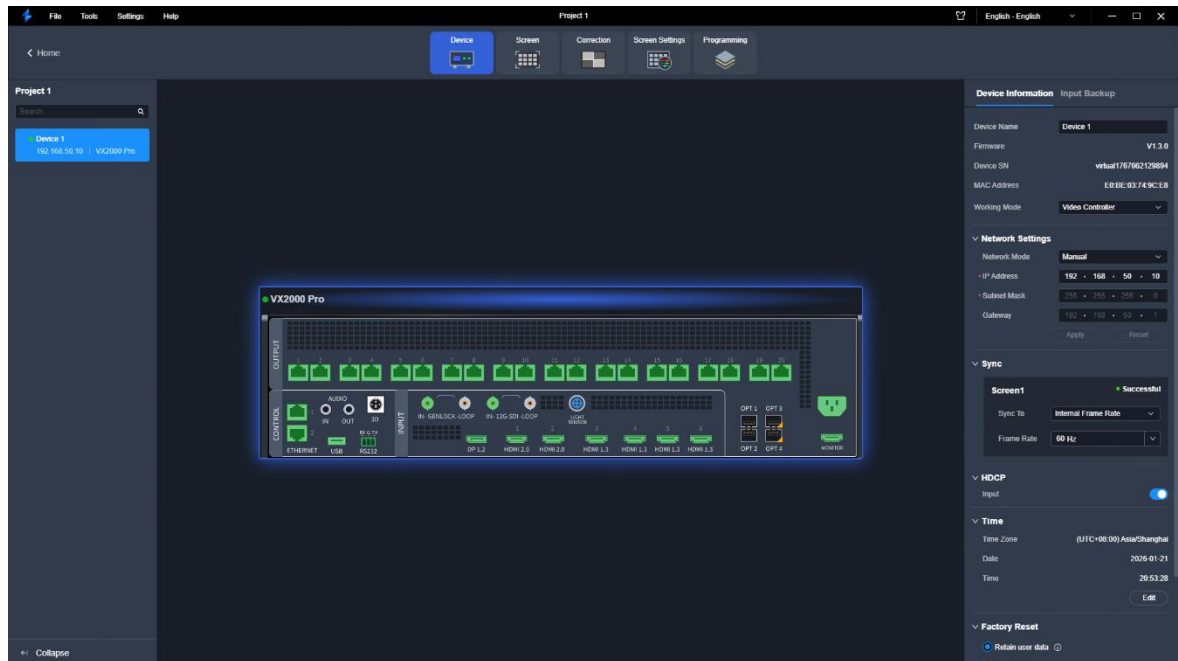

### Note

Click **Collapse** to collapse the device list.

### 7.3.2.1 Rename Device

Change the device name.

#### Prerequisites

None

#### Notes

None

## Interface Example

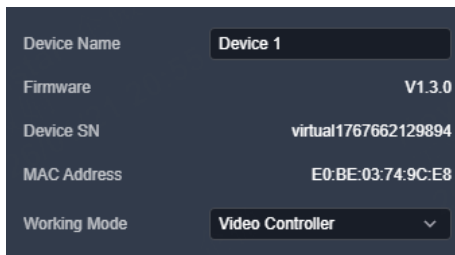

Device Name	Device 1
Firmware	V1.3.0
Device SN	virtual1767662129894
MAC Address	E0:BE:03:74:9C:E8
Working Mode	Video Controller

## Description

Enter a name for the device in the text box next to **Device Name**.

### 7.3.2.2 Switch Working Mode

Switch the device working mode.

## Prerequisites

None

## Notes

Set the device working mode according to the on-site application and screen connections.

## Interface Example



Working Mode	Video Controller
--------------	------------------

## Description

Select **Video Controller**, **Fiber Converter** or **ByPass** from the drop-down list.

### 7.3.2.3 Configure IP Address

Manually set a static IP address for the device or let the device to automatically obtain an IP address.

## Prerequisites

None

## Notes

Devices on different network segments are not automatically discovered. If you change the device IP to another network segment, the device could not be discovered.

## Interface Example

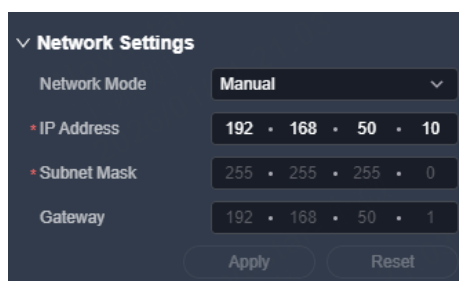

## Description

Configure the following parameters and click **Apply** to make the settings take effect.

Parameter	Description
Network Mode	Select the IP configuration method. <ul style="list-style-type: none"> <li>• Manual: Manually set a static IP address for the device.</li> <li>• DHCP: The device automatically obtains an IP address.</li> </ul>
IP Address	The device IP address
Subnet Mask	The subnet mask of the IP address
Gateway	The default gateway

### 7.3.2.4 Configure Sync Source

Select a sync signal to synchronize all the cascaded device units or synchronize the primary and backup devices to display the output images of all the units in sync.

## Prerequisites

None

## Note

None

## Interface Example

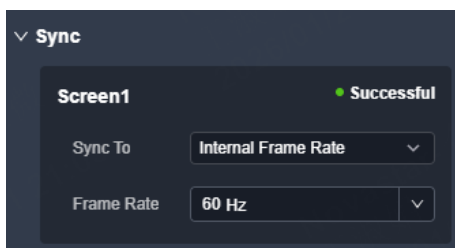

## Description

Parameter	Description
Sync To	<p>Select a sync source.</p> <ul style="list-style-type: none"> <li>Internal Frame Rate: The frame rate of the output image</li> <li>Input source connected to the device video connector: Sync with the frame rate of the selected input source. "X" represents the input source number and its format may vary depending on the actual setup.</li> <li>Genlock: Sync with the frame rate of the Genlock signal.</li> </ul> <p>When the function is enabled, the frame rate of the sync source will be displayed.</p>
Frame Rate	<p>When you select <b>Internal Frame Rate</b>, you can manually set the output frame rate. The default value is 60Hz.</p>

### 7.3.2.5 Configure HDCP

High-bandwidth Digital Content Protection (HDCP) is a form of digital copy protection to prevent copying of digital audio and video content as it travels across connections. When the accessed input source is an HDCP-encrypted one, you need to turn on this function to enable the device to transmit and process the source.

## Prerequisites

None



## Notes

None

## Interface Example



## Description

Parameter	Description
HDCP	Turn on or turn off the function. <ul style="list-style-type: none"><li>• : On</li><li>• : Off</li></ul>

## 7.3.2.6 Configure Date and Time

Configure the time zone, date and time of the device.

## Prerequisites

None

## Notes

None

## Interface Example

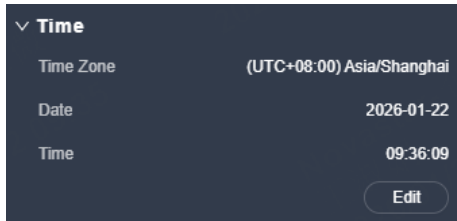

## Description

Click **Edit** and the parameters become editable. Set the time zone, date and time respectively, and then click **Apply**.

## 7.3.2.7 Reset to Factory Settings

Reset the device data and settings to factory default values.

## Prerequisites

None

## Notes

- Please do this with great caution.
- The reset action does not affect the device firmware version.
- Power-off is not allowed during the reset process.
- The device will restart automatically after the reset is completed.

## Interface Example

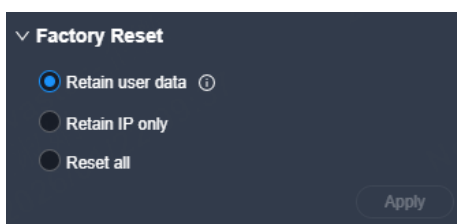

## Description

Select **Retain user data**, **Retain IP only** or **Reset all**, and then click **Apply**.

- Retain user data

Retain the input EDID, imported files, language, device name, device IP, belonged project and restore points.

- Retain IP only

Only retain the device IP address and reset other parameters to factory defaults.

- Reset all

Reset all parameters.

### 7.3.2.8 Standby Mode

Enabling standby mode can effectively reduce energy consumption caused by screen heat generation.

## Prerequisites

None

## Notes

Once the standby mode is enabled, the output image will go black and the output volume will be adjusted to 0. The device LCD screen will also be locked, while other parameters remain unchanged.

## Interface Example



## Description

Parameter	Description
Standby Mode	Turn on or turn off the function. <ul style="list-style-type: none"> <li>• : On</li> </ul>

Parameter	Description
	<ul style="list-style-type: none"> <li><input type="checkbox"/> Off</li> </ul>

### 7.3.2.9 Restart Device

Restart the device.

#### Prerequisites

None

#### Notes

None

#### Interface Example

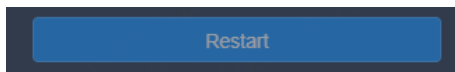

#### Description

Click **Restart**, and then click **Yes** in the displayed dialog box.

### 7.3.2.10 Configure Input Source Backup

Establish a backup relation for two input sources.

#### Prerequisites

None

#### Notes

Input backup rules:

- In each backup group, two input sources serve as the backup for each other.

- The backup relation can only be established if the input connectors have identical capacities.
- The USB source supports the input backup settings.
- Each primary or backup source can have only one backup or primary source.
- Restrictions on input backup functions:

Input sources A and B form a hot backup group. The current input source of the layer is input source A.

- Input A: No signal. Input B: Signal

The layer input source is switched to input B automatically. When input A resumes and input B still has a signal and **Primary Source Preferred** is not enabled, the layer input source will not be changed.

- Input A: No signal. Input B: Signal

The layer input source is switched to input B automatically. When input A resumes, but input B does not have a signal, the layer input source will be changed to input A.

- Input A: No signal. Input B: No signal

The layer input source will not be changed.

- Input A: Signal. Input B: No signal

If you manually switch the layer input source to input B, the source will automatically switch to input A.

## Interface Example

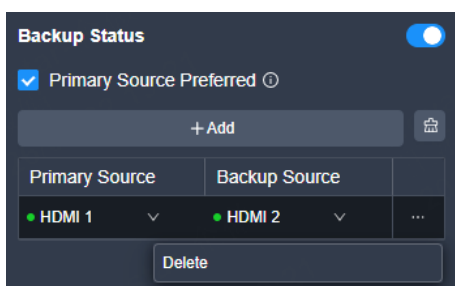

## Description



- Step 1 Select the **Input Source Backup** tab.
- Step 2 Toggle the switch next to **Backup Status** to .
- Step 3 Select or deselect **Primary Source Preferred**.

- If **Primary Source Preferred** is enabled, the system will automatically switch to the primary source once it is restored.
- If **Primary Source Preferred** is disabled, the system will not automatically switch when the primary source is restored and will continue using the backup source.

Step 4 Click **Add** to add a backup relationship.

Step 5 Select a primary source and a backup source respectively from two drop-down lists to establish a hot backup pair.

The green dot ● indicates the source is accessed normally and ready for use.

- To delete a hot backup pair, click  next to the pair and click **Delete**.
- To delete all hot backup pairs, click .

### 7.3.3 Configure Input Properties

Click the target input connector on the graphical device rear panel, and then set the input-related properties in the property area on the right pane.

Figure 7-9 Input properties (VX2000 Pro)

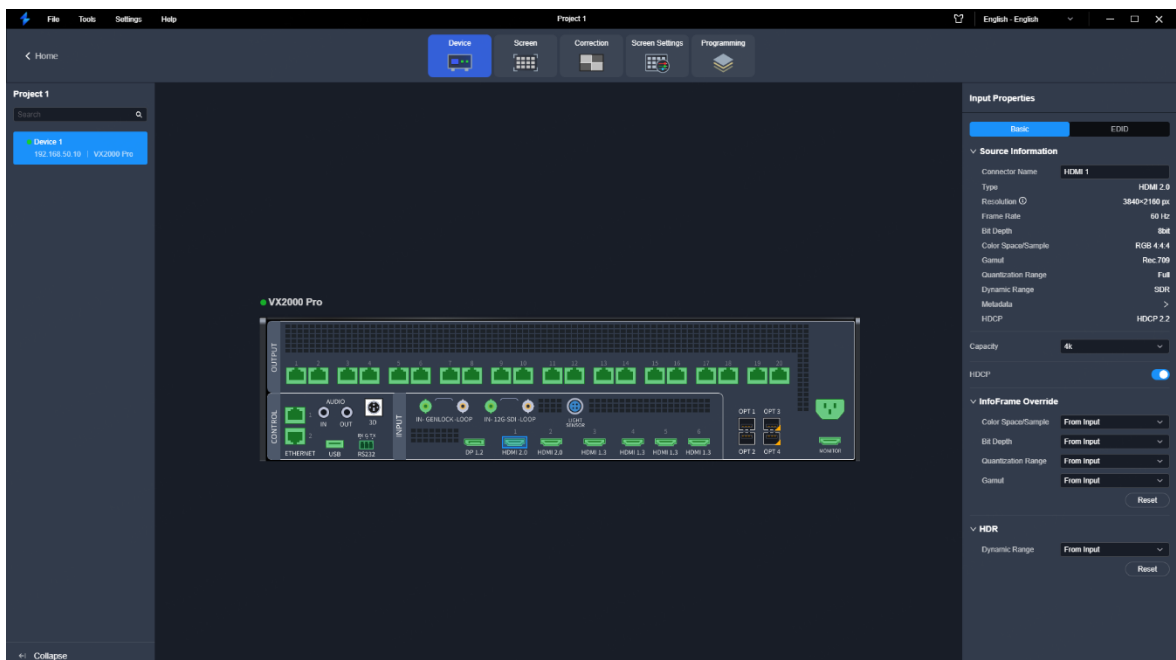

#### 7.3.3.1 View Input Source Info

View the basic properties of the input connector and change the input connector name.

## Prerequisites

A fine signal is connected to the input connector.

## Notes

None

## Interface Example

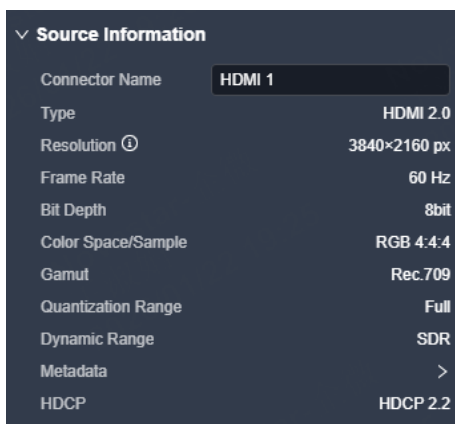

## Description

On the **Basic** tab interface, change the connector name as required.

### Note

Hover the mouse over the target input connector, you can view the input source resolution, frame rate, bit depth and color/sampling rate.

### 7.3.3.2 View OPT Source Info

View the basic properties of the OPT source and change the OPT port name.

## Prerequisites

- The device working mode is set to **Video Controller**.
- OPT 1 and OPT 2 is connected to the OPT ports on the front-end video processor via optical fiber cables. Additionally, a fine signal is connected to the front-end device.

## Notes

Each OPT support the transmission of 1x DL or 2x SL sources.

## Interface Example

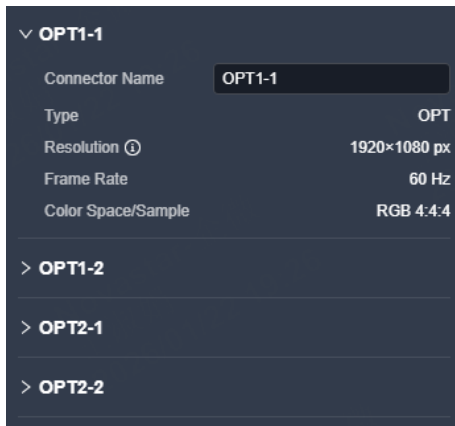

## Description

On the **Input Source** tab interface, change the connector name as required.

### 7.3.3.3 Set Input Connector Capacity

Switch the input connector capacity as desired.

## Prerequisites

None

## Interface Example

When a connector is configured for hot backup, you can no longer switch its capacity.

## Interface Example

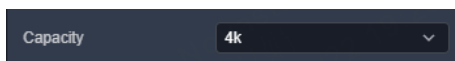

## Description

Capacity	Description
SL	<ul style="list-style-type: none"> <li>• Standard resolution: 1920×1080@60Hz</li> <li>• Custom max width: 2048 (2048×1080@60Hz)</li> <li>• Custom max height: 2048 (1080×2048@60Hz)</li> </ul>
DL	<ul style="list-style-type: none"> <li>• Standard resolution: 3840×1080@60Hz/3840×2160@30Hz</li> <li>• Custom max width: 4096 (4096×1080@60Hz)</li> <li>• Custom max height: 3840 (1080×3840@60Hz)</li> </ul>
4K	<ul style="list-style-type: none"> <li>• Standard resolution: 4096×2160@60Hz/8192×2160@30Hz</li> <li>• Custom max width: 8192 (8192×1080@60Hz)</li> <li>• Custom max height: 8188 (1080×8188@60Hz)</li> </ul>

### 7.3.3.4 Configure Input HDCP

Enable or disable the input HDCP encryption.

#### Prerequisites

None

#### Notes

None

#### Interface Example



#### Description

For an HDCP source, it can only be properly recognized if the HDCP function on the input end is enabled; if the input HDCP is disabled, the HDCP source will by default display a black screen or snow.

For a non-HDCP source, whether the HDCP function on the input end is enabled or not does not affect the normal transmission of the source image into the device.

### 7.3.3.5 Configure InfoFrame Override Parameters

Configure the InfoFrame override parameters of the input source, so that the device can use it when doing some calculations. This action does not change the parameter values that come with the input source.

#### Prerequisites

None

#### Notes

None

#### Interface Example (VX2000 Pro)

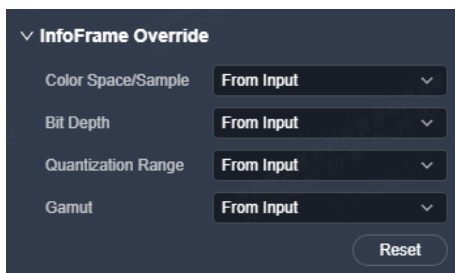

#### Description

On the **Basic** tab interface, configure the following parameters.

Parameter	Description
Color Space/Sample	The sampling format of the input
Bit Depth	The bit depth of the input, i.e., the binary digits to represent a single color
Quantization Range	The quantization range of the input
Gamut	The color gamut standard

Select **From Input** and the device will read the attribute values that come with the input source.

### 7.3.3.6 Set HDR

HDR is the abbreviation for High-Dynamic Range. HDR function can greatly enhance the display image quality, allowing for a more clear and vivid image when the device is used together with the specified receiving cards.

#### Prerequisites

- Use the layer 1 source as an HDR source.
- An HDR source (HDR10/HLG standard) must be used to realize optimal HDR effect.

#### Notes

- An HDR source can be connected to the HDMI 2.0 or 12G-SDI connector only.
- The HDR and 3D functions cannot be used together.
- Using the HDR function paired with receiving cards of different models will reduce the device loading capacity by half or quarter because the HDR input source is 10-bit. Please work out a connection solution in advance.

#### Interface Example

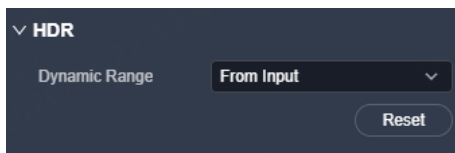

#### Description

Parameter	Description
Dynamic Range	The dynamic range of an HDR source The supported options include <b>HDR10</b> , <b>HLG</b> , <b>off</b> and <b>From Input</b> .

After the HDR source parameters are successfully set, you need to adjust EOTF. For detailed operations, please refer to [Adjust EOTF](#).

Note

When you enable the HDR function, the receiving card supporting this function should be used together. For the specified receiving card model and related information, please refer to our official website ( ).

### 7.3.3.7 Configure EDID

Configure the resolution and frame rate of the input. You can select the standard resolution provided by the device, customize a resolution, or set the advanced parameters.

#### Prerequisites

- SDI does not support this function.
- The front-end device outputs the video source from the graphics card.

#### Notes

It is recommended the advanced settings be carried out by the trained personnel only.

#### Interface Example

Figure 7-10 Standard

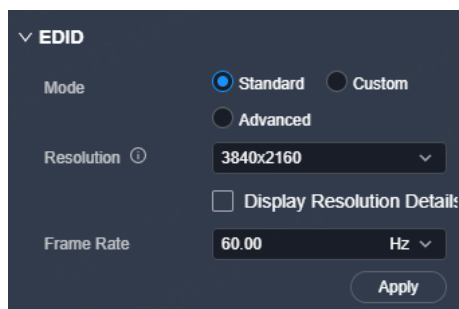

Figure 7-11 Custom

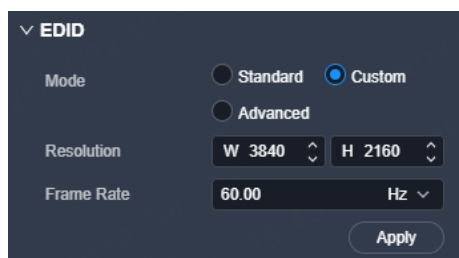
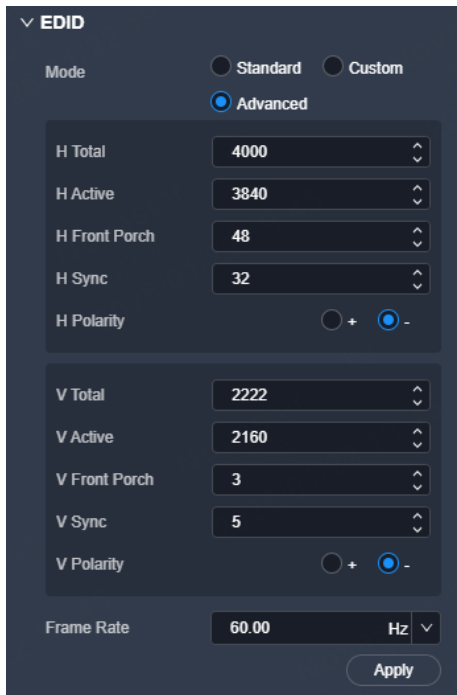

Figure 7-12 Advanced



## Description

On the **EDID** tab interface, select the **Standard**, **Custom** or **Advanced** mode, configure the following parameters, and then click **Apply** after the settings.

Mode	Parameter	Description
Mode	-	Three modes are supported, including <b>Standard</b> , <b>Custom</b> or <b>Advanced</b> .
Standard	Resolution	The number of horizontal pixels and vertical pixels of the image Check the box next to <b>Display Resolution Details</b> to display the resolution detailed information. Config method: Select the desired resolution from the drop-down list.
	Frame Rate	The image frames every second (unit: Hz) Config method: Select the standard common frame rates from the drop-down options. The available frame rates may vary according to the chosen resolution.
Custom	Resolution	The number of horizontal pixels and vertical pixels of the image Config method: Stet the width and height values respectively.
	Frame Rate	The image frames every second (unit: Hz) Config method: Select the standard common frame rates from the

Mode	Parameter	Description
		drop-down options. The available frame rates may vary according to the chosen resolution.
Advanced	H Total	Total pixel count per line
	H Active	The horizontal size in pixels of the active area
	H Front Porch	The offset between the end of the active area and the beginning of the H sync
	H Sync	The horizontal sync width in pixels (or between pixels)
	H Polarity	The polarity of the horizontal sync pulse
	V Total	Total pixel count per column
	V Active	The vertical size in pixels of the active area
	V Front Porch	The offset in lines between the end of the active output area and the beginning of V sync
	V Sync	The vertical sync width in rows (or between rows)
	V Polarity	The polarity of the vertical sync pulse
	Frame Rate	The image frames every second (unit: Hz)  Config method: Select the standard common frame rates from the drop-down options or set the frame rate value.

### 7.3.3.8 Configure Compatibility with Mac

When the device is incompatible with the EDID of a Mac system, you may activate this feature to resolve the issue.

#### Prerequisites

None



#### Notes

None

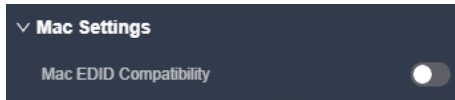
## Interface Example



## Description

Parameter	Description
Mac EDID Compatibility	Turn on or turn off the function. <ul style="list-style-type: none"> <li>• : On</li> <li>• : Off</li> </ul>

### 7.3.3.9 Import and Export EDID

When compatibility problem occurs on an input connector, import an intact EDID file into the device; or export an EDID file from a device and provide the EDID file to other devices or input connectors to solve the compatibility issues.

## Prerequisites

SDI does not support this function.

## Notes

- Each input connector supports importing one EDID file only.
- Once the EDID file is imported, the input connector will recognize and apply the parameters from the file.

## Interface Example

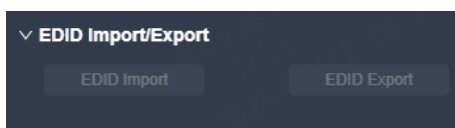

## Description

- EDID Import

On the **EDID** tab interface, click **EDID Import**. In the dialog box that appears, select an EDID file and click **Open**.

- EDID Export

On the **EDID** tab interface, click **EDID Export**. In the dialog box that appears, select a path and click **Save**.

---

 Note

If you need to modify the content of an imported EDID file, just modify it and then re-import it to overwrite the original one.

---

## 7.3.4 Configure Output Properties

### 7.3.4.1 Set OPT Ports

Set the OPT working mode and loop mode.

#### Prerequisites

The device working mode is set to **Video Controller**.

#### Notes

None

#### Interface Example

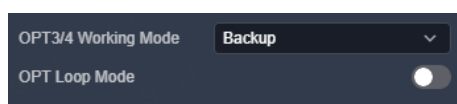

#### Description

Click the OPT port on the device rear panel, and then set the following parameters.

Table 7-1 OPT working mode

Device Model	Parameter	Description
VX400 Pro	OPT 2 Working Mode	OPT 2 working mode Config method: Select <b>Copy</b> or <b>Backup</b> from the drop-down list. <ul style="list-style-type: none"> <li>• <b>Copy</b>: OPT 2 copies the output on Ethernet port 1~4.</li> <li>• <b>Backup</b>: OPT 2 backs up the output on Ethernet port 1~4.</li> </ul>
VX600 Pro		OPT 2 working mode Config method: Select <b>Copy</b> or <b>Backup</b> from the drop-down list. <ul style="list-style-type: none"> <li>• <b>Copy</b>: OPT 2 copies the output on Ethernet port 1~6.</li> <li>• <b>Backup</b>: OPT 2 backs up the output on Ethernet port 1~6.</li> </ul>
VX1000 Pro		OPT 2 working mode Config method: Select <b>Copy</b> or <b>Backup</b> from the drop-down list. <ul style="list-style-type: none"> <li>• <b>Copy</b>: OPT 2 copies the output on Ethernet port 1~10.</li> <li>• <b>Backup</b>: OPT 2 backs up the output on Ethernet port 1~10.</li> </ul>
VX2000 Pro	OPT 3/4 Working Mode	OPT 3 and OPT 4 working modes Config method: Select <b>Copy</b> or <b>Backup</b> from the drop-down list. <ul style="list-style-type: none"> <li>• <b>Copy</b>: OPT 3 and OPT 4 copy the output on Ethernet port 1~10 and 11~20 respectively.</li> <li>• <b>Backup</b>: OPT 3 and OPT 4 back up the output on Ethernet port 1~10 and 11~20 respectively.</li> </ul>

 Note

- After the OPT working mode is set to **Copy**, the OPT ports on the graphical device panel will be highlighted.
- After the OPT working mode is set to **Backup**, the backup icons will be displayed at the bottom right corner of the OPT ports on the graphical device panel.

Table 7-2 OPT loop mode

Device Model	Parameter	Description
VX400 Pro/VX600 Pro/VX1000 Pro/VX2000 Pro	OPT Loop Mode	Turn on or turn off the function. <ul style="list-style-type: none"> <li>• On: </li> </ul>

Device Model	Parameter	Description
		After this function is enabled, the video signal accessed by OPT 1 will be looped out via OPT 2. • Off: <input type="checkbox"/>

### 7.3.4.2 Set Monitoring

Real-time display of the output image via the monitor connected is supported. You can monitor whether the output is normal and adjust the display ratio of the monitoring image on the monitor to avoid image distortion.

#### Prerequisites

None

#### Notes

#### Interface Example (VX2000 Pro)

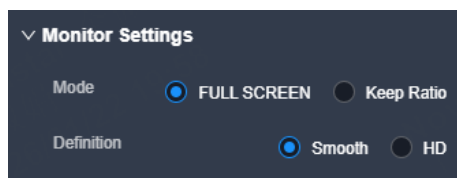

#### Description

Click the **Monitor** connector on the device rear panel, and then set the following parameters.

Parameter	Description
Scaling Mode	The options include <b>Keep Ratio</b> and <b>Full Screen</b> (default). <ul style="list-style-type: none"> <li>• Keep Ratio: Keep the ratio of the original output image to display.</li> <li>• Full Screen: Display the output image in full screen.</li> </ul> <div style="background-color: #f0f0f0; padding: 5px; margin-top: 10px;"> <b>Note</b>                      When <b>Keep Ratio</b> is selected, the blank area that the output image cannot cover the entire monitor screen will be automatically filled with solid black.                 </div>
Definition	The supported options include <b>Smooth</b> and <b>High-Definition</b> .

Parameter	Description
	<ul style="list-style-type: none"> <li>• Smooth: The monitoring image definition is 1920×1080@60Hz.</li> <li>• High-Definition: The monitoring image definition is 3840×2160@60Hz.</li> </ul>

## 7.4 Screen Configuration

### 7.4.1 Configure Sub-Screens

When a single device is used to load to multiple physical screens (for example, to display the same or different content simultaneously on multiple welcome screens or information screens), the sub-screen function can be enabled. By configuring an independent sub-screen for each physical screen, their display effects can be controlled separately.

#### 7.4.1.1 Add Sub-Screens

Configure an independent sub-screen for each physical screen, allowing for independent control of the images and effects on each screen.

#### Prerequisites

None

#### Notes

Up to 5 sub-screens can be created.

#### Interface Example

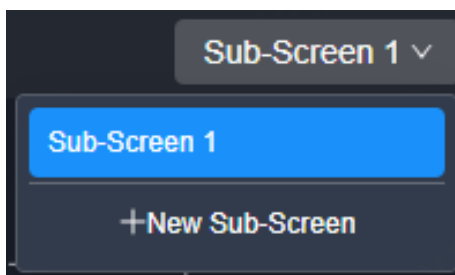



## Description

Click **Sub-Screen** at the top right corner, and then click **New Sub-Screen** in the popup menu to add a sub-screen. The default name is **Sub-Screen 1**.

### Note

If you have configured the screen topology before adding a sub-screen, the configured cabinets will be automatically assigned to the first created sub-screen by default.

In the sub-screen list, you can perform the following operations.

- Change name: Hover the mouse over the target sub-screen, and then click  that appears. Enter a new name, and then click elsewhere in the interface to complete the sub-screen name change.
- Delete sub-screen: Hover the mouse over the target sub-screen, and then click  that appears. In the popup dialog box, click **OK** to delete the sub-screen.

### Note

- When deleting a sub-screen, its configured cabinets will also be deleted. Please proceed with caution.
- When deleting the last sub-screen, its screen topology will be saved to the initial screen.

## 7.4.1.2 Set Sub-Screens

For a sub-screen, you can perform related operations, including screen topology configuration, cabinet correction and screen adjustment, realizing independent control of each physical screen.

## Prerequisites

None

## Notes

- If you use the quick configuration function to configure the LED screen on the device LCD panel, all sub-screens created in Unico will be cleared.

- You can add, delete or rename a sub-screen on the **Screen** interface only. For switching or configuring the sub-screen, please perform the related operations on the **Correction** or **Screen Settings** interface.

## Interface Example

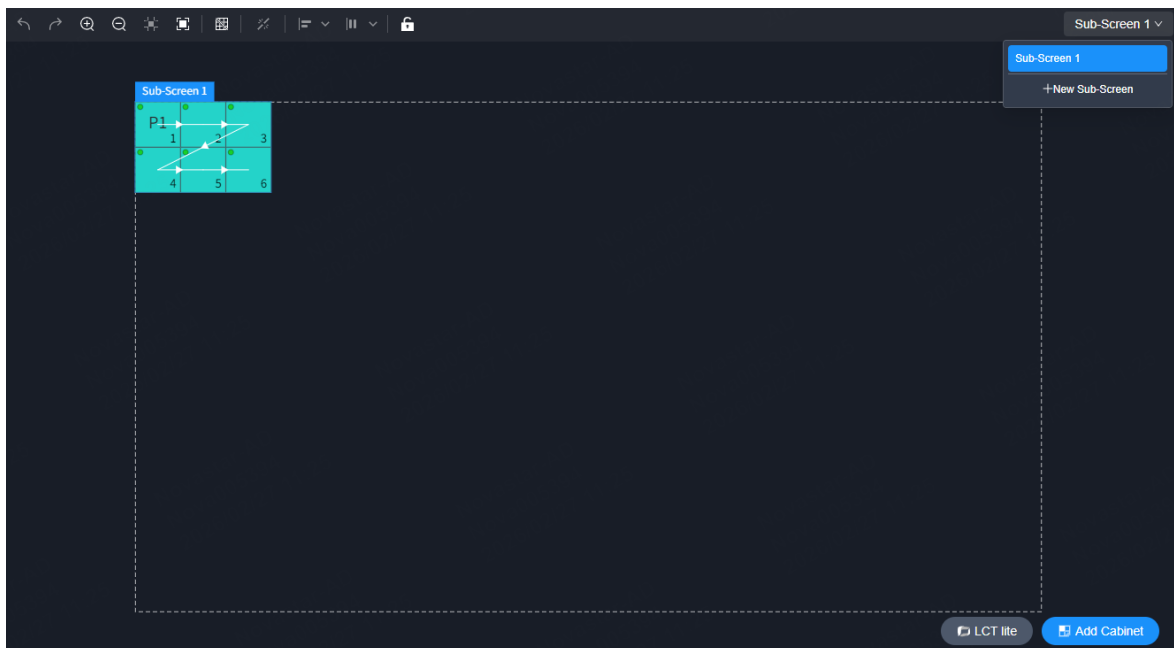

## Description

Click **Sub-Screen** at the top right corner, and then select the target sub-screen to switch to it.

After switching to the target sub-screen, you can configure the screen topology, correct the cabinet and adjust the screen on the **Screen**, **Correction** or **Screen Settings** interface respectively. For detailed operations, please refer to the related sections in this manual.

### Note

- On the **Screen** interface, cabinets configured for all sub-screens will be displayed, and the cabinets of the current screen will be displayed at the top and can be selected; while, cabinets of other sub-screens will be displayed in gray at the bottom and cannot be selected.
- On the **Correction** and **Screen Settings** interfaces, only cabinets of the current sub-screen will be displayed.
- On the **Screen Settings** interfaces, click **Sub-Screen** at the top right corner, and then select **All** in the popup menu to adjust the related parameters, such as brightness and Gamma, for all sub-screens.

## 7.4.2 Configure Screen Topology

Configure the cabinet topology to complete the wiring connections of the physical or empty cabinets.

### 7.4.2.1 Configure Online Cabinets

#### Prerequisites

The device is connected and cabinets are connected to the device.

#### Notes

None

#### Description

Step 1 Click **Screen** at the top to enter the screen configuration interface.

Figure 7-13 Screen configuration (VX2000 Pro)

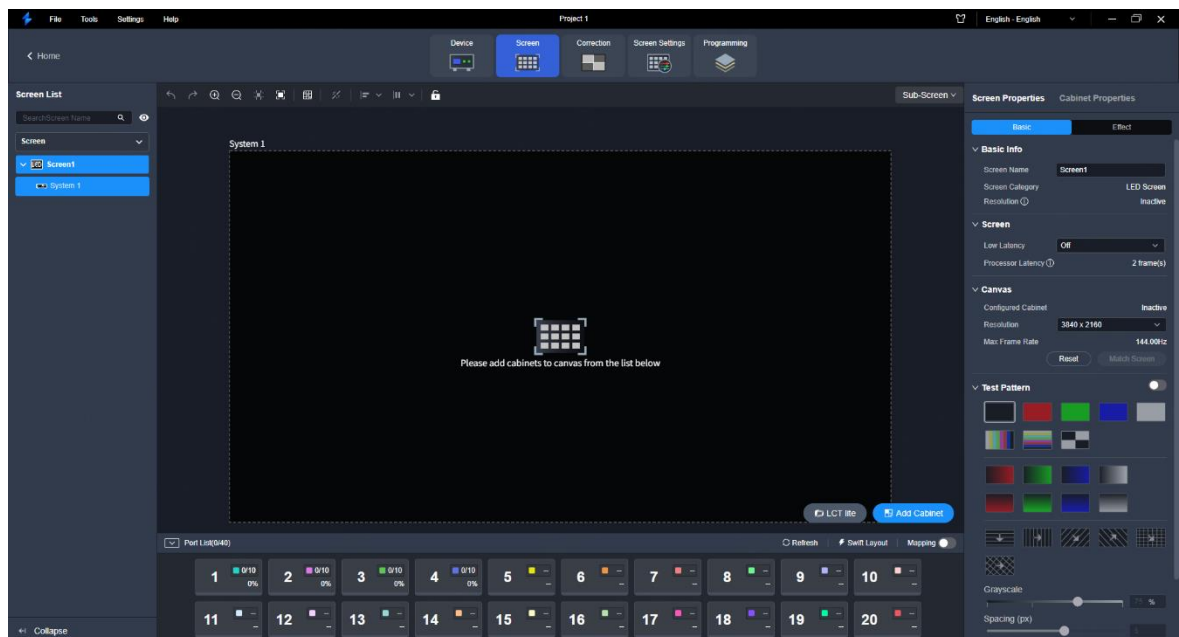

Step 2 Select the desired screen from the screen list on the left.

Step 3 In the **Ethernet Port List** area, select an Ethernet port and then drag and click the mouse in the topology area to add cabinets.

The cabinets will be automatically connected when you are adding them, as shown in [Figure 7-14](#). The Ethernet port's loading capacity information will be displayed, as shown in [Figure 7-15](#).

Figure 7-14 Cabinets connected automatically

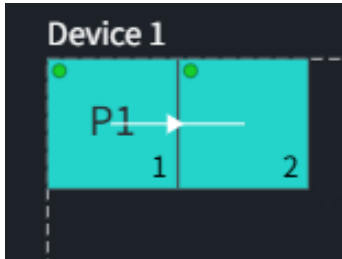
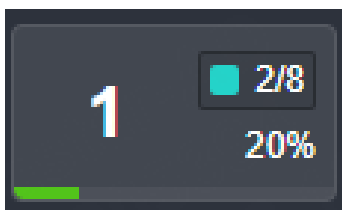

Figure 7-15 Ethernet port capacity



- 1: The Ethernet port number
- 2/8: Configured cabinets loaded by this Ethernet port/Total cabinets loaded by this Ethernet port
- 20% and progress bar: Loading capacity used by the configured cabinets/Total loading capacity of this Ethernet port

#### Note

Descriptions for shortcut keys:

- Batch select cabinets: Hold the **Shift** key and drag with the left mouse button to select, or simply drag the mouse to select multiple cabinets at a time.
- When no Ethernet ports are selected, use the arrow keys to finely adjust the position of the selected cabinet. Each press moves the cabinet by 1 pixel.

Description for **Swift Layout**:

- Requirements: If all the cabinets loaded by the Ethernet ports have the same model, resolution, and connection topology, you can use the **Swift Layout** function to quickly add and connect the cabinets for all the Ethernet ports.
- Operating procedure: Click  and then drag the mouse in the topology area to add cabinets that match the actual requirements. In the properties area, select a layout and click **Done**.

**Step 4** Select other Ethernet ports and continue to add cabinets until all cabinets are connected.

 Note

The configured cabinets can be rewired by selecting other Ethernet ports to load them.

**Step 5** For cabinets that have the same size and consecutive serial numbers, if you want to change the cabinet connection topology, select the cabinets and then select a quick topology under **Quick topo** in the properties area, as shown in [Figure 7-16](#). For other cabinets, skip this step.

Figure 7-16 Quick topology

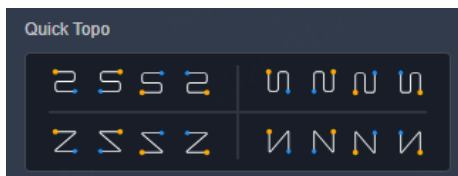

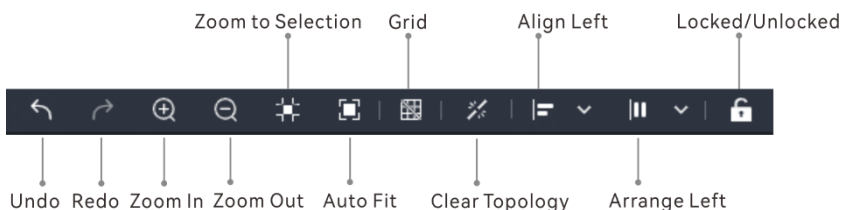

**Step 6** Do any of the following to arrange and align the cabinets and cabinet groups to let the cabinet positions meet the display requirements.

- Use the function buttons.

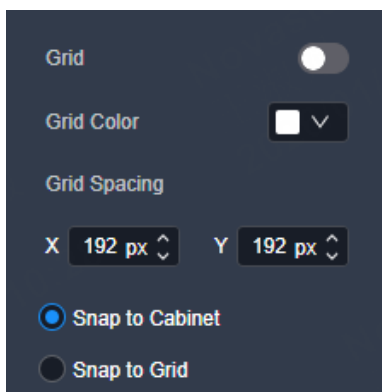

- **Zoom to Selection:** The selected element is zoomed and displayed in the center of the canvas.
- **Auto Fit:** The canvas size is automatically adjusted to fit the topology area size.
- Click  to show its drop-down menu shown below. The menu can be used to set the canvas grid.



**Grid:** When toggled on () , a grid is displayed on the canvas. If you do not need to display the grid, set the switch to .

**Grid Color:** Set the grid color.

**Grid Spacing:** Set the spacing of horizontal and vertical lines of the grid. The spacing is set to the resolution of the first cabinet by default.

**Snap to Cabinet:** When positioning a cabinet near another one, the cabinet being moved will automatically align and snap to the edge of the adjacent cabinet, effectively eliminating gaps.

**Snap to Grid:** The cabinet will be snapped to the grid.

- Use the right-click function menu
  - **Select String:** Select all the cabinets on the connection line of the current cabinet.
  - **Select Same Cabinets:** Select the cabinets of the same model of the current cabinet.
  - **Blackout:** Blackout the output image displayed on the current cabinet.
  - **Freeze:** Freeze the output image displayed on the current cabinet.
  - **Swap:** Swap the positions of the two selected cabinets.
  - **Group:** Select the desired cabinets and right click on them. Click **Group** in the context menu, and then the selected cabinets will be grouped for batch control. To set the group name and color, please select the group and set them in the properties area. You can also use the keyboard shortcuts **Ctrl+G** to perform the grouping operation.
  - **Ungroup:** Ungroup the cabinets. You can also use the keyboard shortcuts **Ctrl+Shift+G** to perform this action.
  - **Add to:** Add the selected cabinets to a group.
  - **Clear Topology:** Clear the current cabinet topology.
  - **Delete:** Delete the selected cabinet. You can also use the keyboard shortcuts **Del** to perform this action.
- Right click on the canvas edge and use the function menu

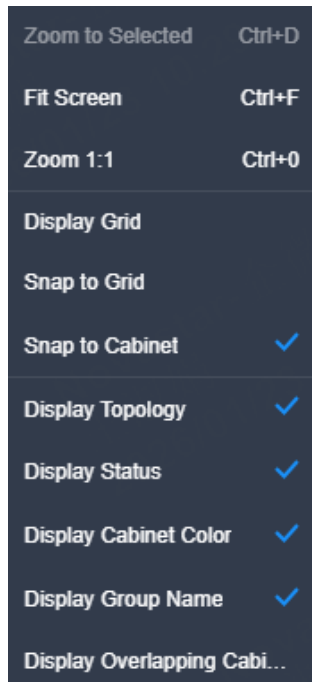

- Zoom to Selected: The selected element is zoomed and displayed in the center of the canvas.
- Fit Screen: The canvas size is automatically adjusted to fit the topology area size.
- Zoom 1:1: The canvas size equals the input source resolution.
- Display Grid: Display a grid on the canvas.
- Snap to Grid: The cabinet will be snapped to the grid.
- Snap to Cabinet: When positioning a cabinet near another one, the cabinet being moved will automatically align and snap to the edge of the adjacent cabinet, effectively eliminating gaps.
- Display Topology: Display the cabinet connections.
- Display Status: Display the cabinet status.  
Green: The cabinet is in the topology area.  
Gray: The cabinet is offline.  
Orange: Some part of the cabinet is in the topology area.  
Red: The entire cabinet is out of the topology area.
- Display Cabinet Color: Display a color icon at the top right corner of an Ethernet port. Once an Ethernet port is loading cabinets, a color icon will be displayed which is of the same color as the cabinet color.
- Display Group Name: Display the cabinet group name.
- Display Overlapping Cabinets: Display the overlapping cabinets.

Figure 7-17 Online cabinet topology (VX2000 Pro)

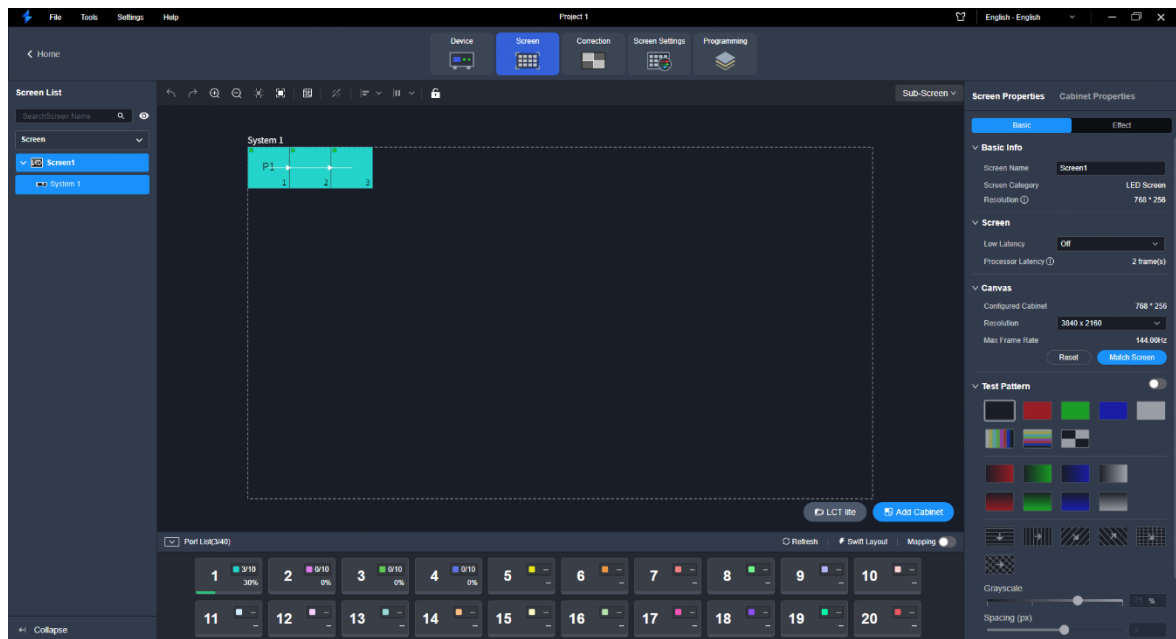

**Note**

- Use either Unico or NovaLCT to configure the screen.
- Mapping is used to show the relations between the cabinets of the LED screen and the sending devices so that you can view or check the connections between the cabinets.
- Click **LCT Lite** to run the software in which you can configure the receiving card parameters.
- In the menu bar, go to **File > Export Screen Config File** to export the configured cabinet topology as a file (.scr).
- In the menu bar, go to **File > Import Screen Config File** to import a saved screen configuration file for quick topology.

## 7.4.2.2 Configure Empty Cabinets

### Prerequisites

None

### Notes

None

## Description

Step 1 Click **Screen** at the top of the page to enter the screen configuration page.

Figure 7-18 Screen configuration (VX2000 Pro)

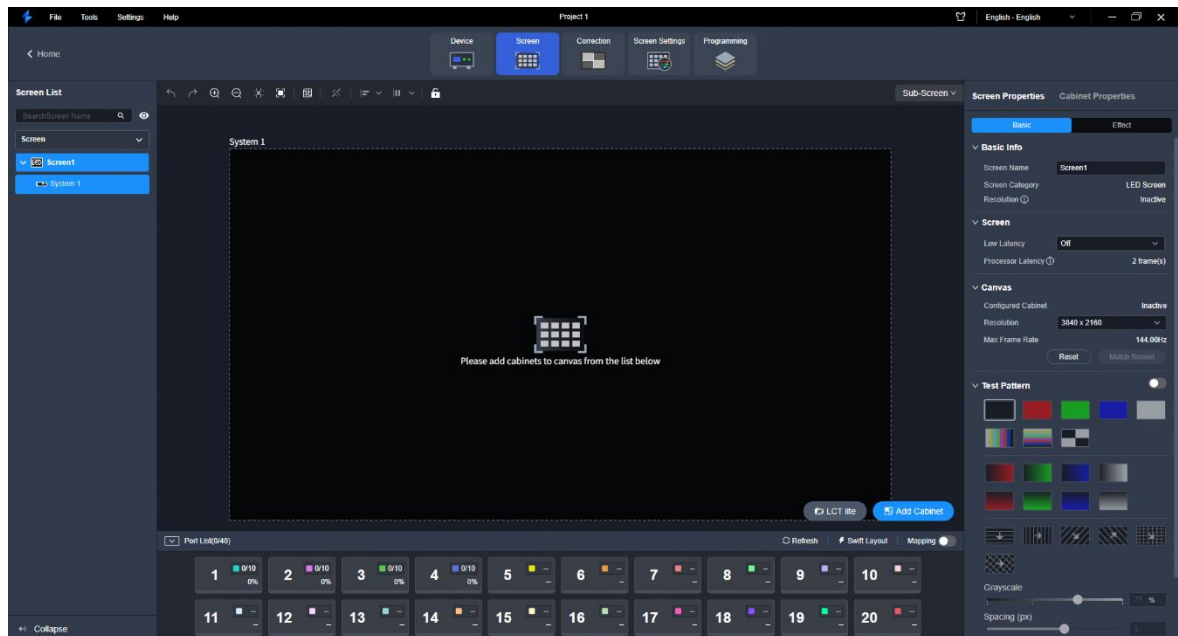

Step 2 Select the desired screen from the screen list on the left.

Step 3 Click **Add Cabinet**.

Figure 7-19 Add cabinets

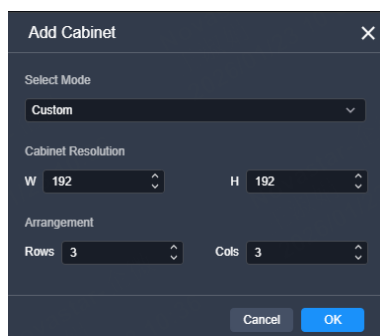

Step 4 Select the desired cabinet existing in the cabinet library from the drop-down list below **Select Mode**.

Step 5 (Optional) If no cabinet configuration files (.rcfgx) are imported to the cabinet library, you can set the width and height for the empty cabinet.

Step 6 Set the rows and columns of cabinets. After settings are done, click **OK** to confirm.

Step 7 In the topology area, click the left mouse button to add cabinets with the set rows and columns.

Figure 7-20 Add empty cabinets (VX2000 Pro)

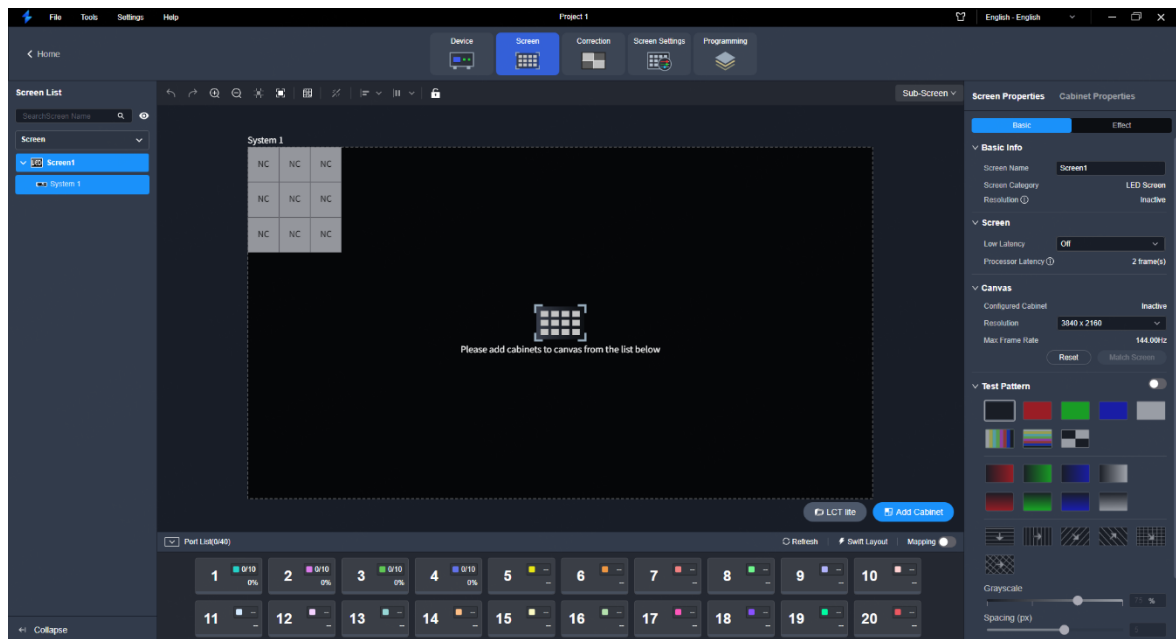

**Step 8** Select the desired Ethernet port and drag or click the mouse in the empty cabinets to complete the wiring.

**Note**

Descriptions for screen topology:

- Use format painter.

Method I: Select an Ethernet port first, and then select the desired data flow. The cursor will change to a format painter icon. Drag the mouse in the empty cabinets to automatically complete the wiring according to the selected data flow.

Method II: Select the desired data flow first, and the cursor will change to a format painter icon. Then, select an Ethernet port and drag the mouse in the empty cabinets to complete the wiring according to the selected data flow.

- Drag the mouse to complete the wiring.

After selecting an Ethernet port, there is no need to choose the data flow. Simply drag the mouse in the empty cabinets, and the system will automatically complete the wiring according to the mouse movement.

- Quick topology

Select one or multiple empty cabinets, select the desired data flow, and then select the target Ethernet port to complete the wiring.

- Use arrow keys.

Select an Ethernet port and confirm the wiring starting position, and then use arrow keys to control the wiring path.

Step 9 Select other Ethernet ports and continue wiring until all cabinets are connected.

Figure 7-21 Empty cabinet topology (VX2000 Pro)

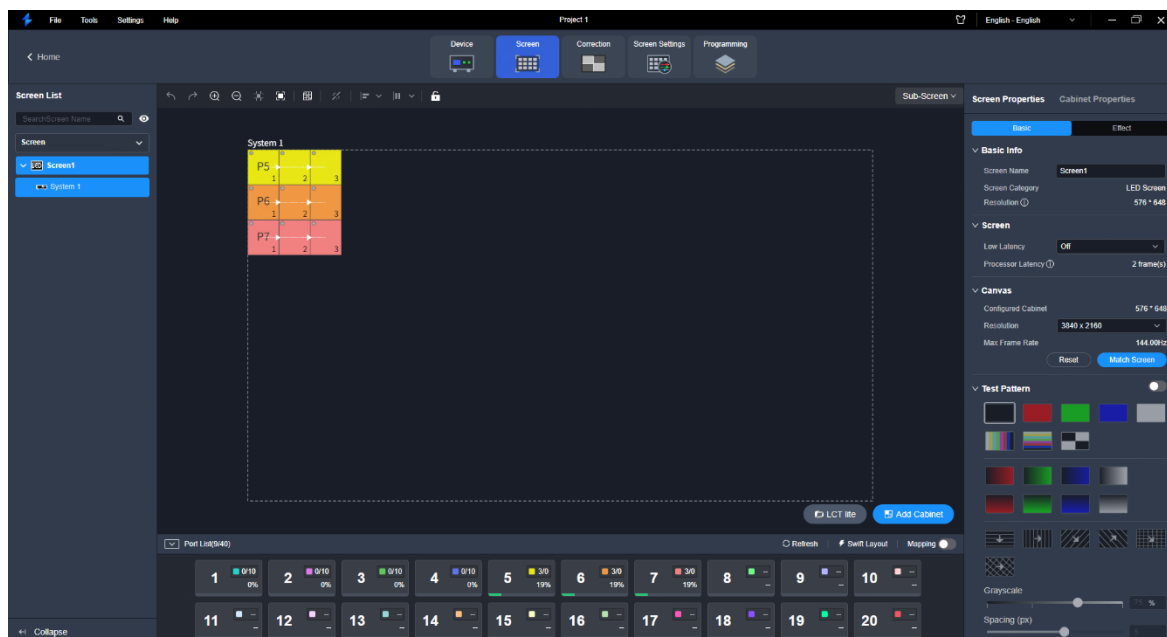

Cabinet connection status:

- **P1:** The cabinet is loaded by Ethernet port 1.
- **NC:** An empty cabinet

Step 10 Connect the on-site cabinets based on the configured topology.

**Note**

When configuring the empty cabinet, you can leave the desired cabinet without wiring as shown below based on the on-site screen loading requirements.

### 7.4.3 Configure Screen Properties

Set the screen-related properties in the property area on the right pane.

### 7.4.3.1 Rename Screens

Change the screen name.

#### Prerequisites

None

#### Notes

None

#### Interface Example

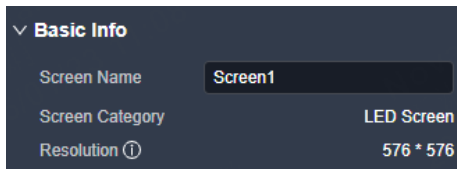

#### Description

On the **Basic** tab interface, change the screen name as required.

### 7.4.3.2 Configure Low Latency

When the input source travels from where it comes to the processing device, sending device and then the receiving card, latency exists inevitably. Turning on this function can effectively help to reduce the latency from the input to output.

#### Prerequisites

None

#### Notes

If you set the low latency mode to **Auto**, the system will determine whether to enable the low latency based on the screen topology. The specific rules are as follows.

- For a single Ethernet port with vertical cabling and no overlap in the Y direction, the low latency will be automatically enabled if all the following requirements are met; otherwise, it will be disabled.
  - The cabinets loaded by one Ethernet port cannot be overlapped, while blank configurations are allowed.
  - The circumscribed rectangles of all cabinets loaded by Ethernet ports must be aligned at the top of the canvas.
  - No need to keep the same cabinet size.

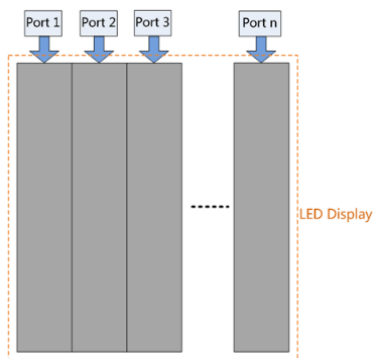

- For free topology, the low latency will be automatically enabled if all the following requirements are met; otherwise, it will be disabled.
  - The cabinets loaded by one Ethernet port cannot be overlapped, while blank configurations are not allowed.
  - The circumscribed rectangles of all cabinets loaded by Ethernet ports must be aligned at the top of the canvas. The size of the circumscribed rectangle cannot exceed 650,000 pixels.
  - The size of all cabinets must be the same.

## Interface Example

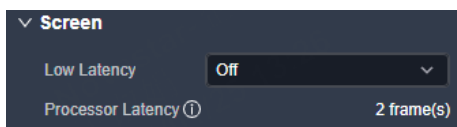

## Description

Parameter	Description
Low Latency	Turn on of turn off the function. <ul style="list-style-type: none"> <li>• Off: Turn off the function. (Default option)</li> </ul>

Parameter	Description
	<ul style="list-style-type: none"> <li>On: Turn on the function. The device latency can be reduced by 1 frame.</li> </ul> <p> <b>Note</b></p> <p>After you manually enable the low latency function, it is advisable to align the circumscribed rectangle loaded by each Ethernet port at the top of the canvas. If not aligned, the loading capacity will be reduced. For calculating the actual loading capacity, please refer to <a href="#">Loading Capacity Calculation Method in Low Latency Mode</a>.</p> <ul style="list-style-type: none"> <li>Auto: If you set the low latency mode to <b>Auto</b>, the system will determine whether to enable the low latency based on the screen topology. If the wiring meets the rules, low latency will be enabled automatically; otherwise, it will be disabled automatically. For specific rules, please refer to the notes in this section.</li> </ul>

### 7.4.3.3 Set Canvas Size

#### Prerequisites

None

#### Notes

None

#### Interface Example

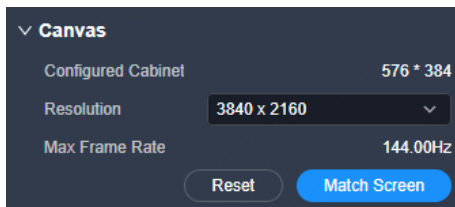

#### Description

On the **Basic** tab interface, configure the following parameters.

Parameter	Description
Resolution	The size of the canvas, that is the size of the device effective loading area

Parameter	Description
	<p>Config method:</p> <ul style="list-style-type: none"> <li>• Select the desired resolution from the drop-down list.</li> <li>• Select <b>Custom</b> from the drop-down list, and then set the width and height values.</li> </ul> <p>Generally, the size of the effective loading area should match with that of the physical screen.</p> <p>After you complete the settings, the system will automatically calculate the max output frame rate at the current resolution.</p>
Match Screen	<p>After the screen configuration is completed, click <b>Match Screen</b> and the system will automatically change the canvas size to the size of the circumscribed rectangles.</p>

### 7.4.3.4 Configure Test Patterns

Test patterns are used to check the connection relation between the output connectors and the screen, and check whether the screen display is good.

#### Prerequisites

None

#### Notes

None

## Interface Example

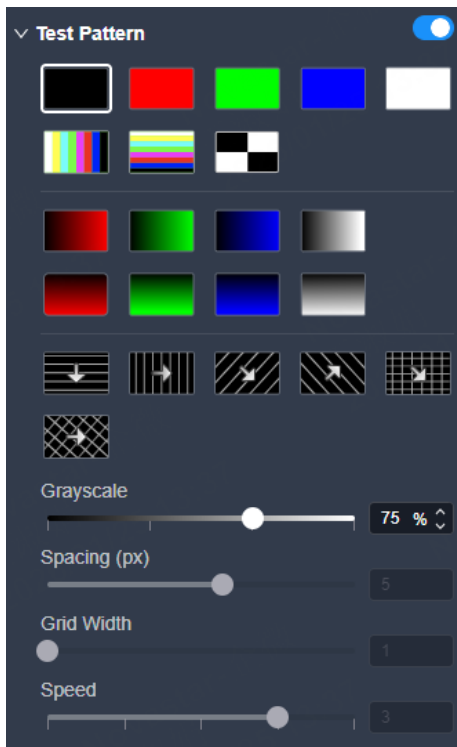

## Description

On the **Basic** tab interface, configure the following parameters.

Parameter	Description
Test Pattern	Turn on or turn off the function. <ul style="list-style-type: none"> <li>• : On</li> <li>• : Off</li> </ul> After the function is enabled, select the desired test pattern.
Grayscale	Set the grayscale of the test pattern.
Spacing Level	Set the spacing between different color areas. If a multi-color test pattern is selected, this parameter is available.
Spacing (px)	Set the spacing between the lines. If a grid test pattern is selected, this parameter is available.
Grid Width	Set the width of the grid lines.
Speed	Set the moving speed of the lines.

### 7.4.3.5 Configure Output Color

Configure the output color parameters.

#### Prerequisites

None

#### Notes

None

#### Interface Example

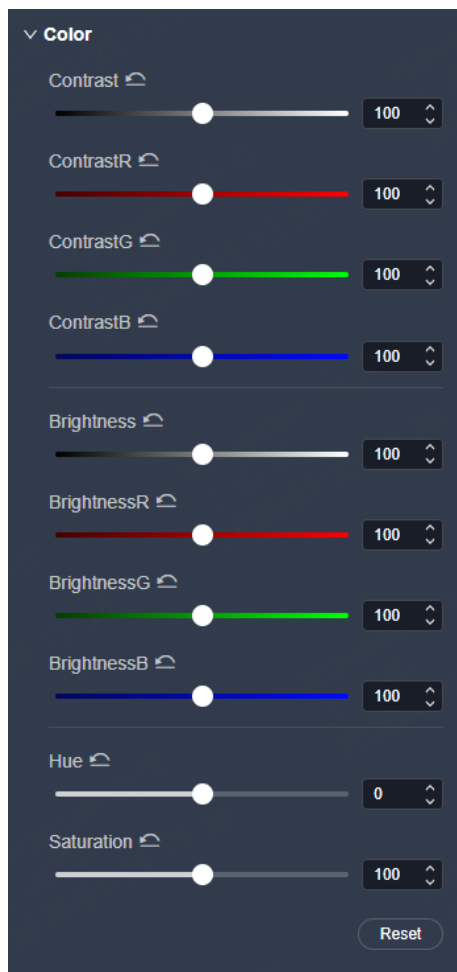

## Description

On the **Effect** tab interface, configure the following parameters.

Parameter	Description
Contrast	The ratio of the luminance of the brightest color to that of the darkest color Adjust the contrast value either as a whole or individually adjust the RGB components.
Brightness	The shading of lights in the image Adjust the brightness value either as a whole or individually adjust the RGB components.
Hue	The relative degree of how bright or dark the image is
Saturation	The color purity of the image The higher the value, the more vivid the color.

## 7.4.4 Configure Cabinet Properties

### 7.4.4.1 View Cabinet Library

#### Prerequisites

None

#### Notes

None

## Interface Example

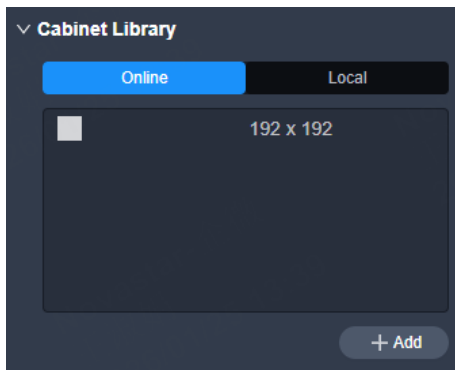

## Description

View the online cabinets or cabinet configuration files in the cabinet library.

Click **Add** to upload the cabinet file to the local pack or device pack, or add the virtual cabinet to the local pack. For detailed operations, please refer to [Manage Cabinet Library](#).

## 7.4.4.2 Change Cabinet Resolutions

### Prerequisites

None

### Notes

The changed resolution of the configured cabinet should be a multiple of the module resolution to ensure normal display.

## Interface Example

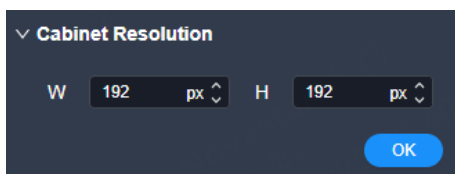

## Configuration

Select the desired cabinet in the canvas area, and then set the cabinet width and height on the **Cabinet Properties** tab interface. After settings are done, click **OK** to complete the editing.

### 7.4.4.3 View Cabinet Info

View cabinet-related info.

#### Prerequisites

None

#### Notes

None

#### Interface Example

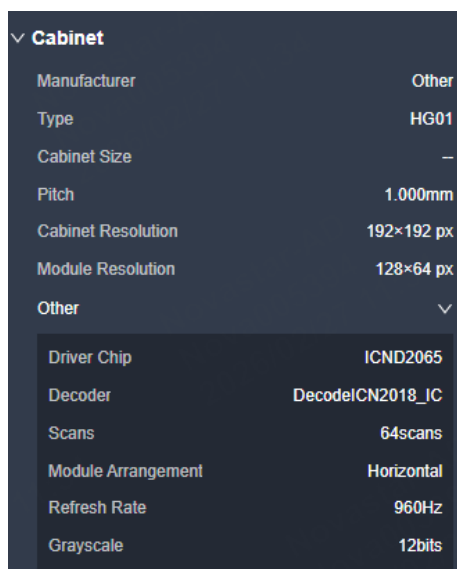

#### Description

None

## 7.4.4.4 Configure Cabinet Groups

Change the cabinet group name and background color.

### Prerequisites

A cabinet group has been created.

### Notes

None

### Interface Example

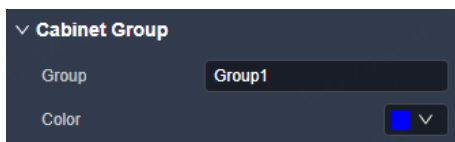

### Description

On the **Cabinet Properties** tab interface, configure the following parameters.

Parameter	Description
Group	The name of the cabinet group Config method: Enter a new group name, and then click elsewhere in the interface to complete the group name change.
Color	The background color of the group name Config method: Click the color block next to <b>Color</b> , and then select a standard color or enter RGB values to set the background color of the cabinet group name.

## 7.4.4.5 Configure Cabinet Positions

### Prerequisites

None

## Notes

The cabinet rotation in 90° increments feature is only supported by certain models of receiving cards, as detailed below:

Model	Description
CA50E, XA50Pro, A10s Pro	Supported by all versions.
A8s-N, A7s Plus, A5s Plus	Supported by V4.9.0.0 or later.

## Interface Example

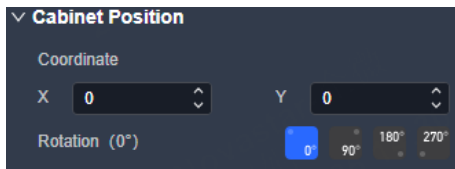

## Description

On the **Cabinet Properties** tab interface, configure the following parameters.

Parameter	Description
Coordinate	The position of the cabinet on the canvas <ul style="list-style-type: none"> <li>• X: X coordinate of the cabinet on the canvas</li> <li>• Y: Y coordinate of the cabinet on the canvas</li> </ul>
Rotation (0°)	Rotate the cabinet. Once the cabinet is rotated, the input source will display at the adjusted angle.  Supported rotation angles: 0°, 90°, 180° and 270°

### 7.4.4.6 Set Cabinets

#### Prerequisites

None

#### Notes

None

## Interface Example

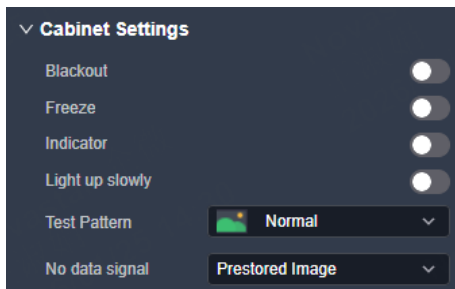

## Description

On the **Cabinet Properties** tab interface, configure the following parameters.

Parameter	Description
Blackout	Turn on or turn off the function. <ul style="list-style-type: none"> <li>• : On</li> <li>• : Off</li> </ul>
Freeze	Turn on or turn off the function. <ul style="list-style-type: none"> <li>• : On</li> <li>• : Off</li> </ul>
Indicator	Turn on or turn off the function. <ul style="list-style-type: none"> <li>• : On</li> <li>• : Off</li> </ul>
Light up slowly	Turn on or turn off the function. <ul style="list-style-type: none"> <li>• : On</li> <li>• : Off</li> </ul> <p>Once enabled, the display brightness will slowly change from 0 to the target value after the screen is powered on.</p>
Test Pattern	Select a test pattern to perform screen aging test and troubleshoot problems.
No data signal	Set the display image after the Ethernet cable is disconnected. <ul style="list-style-type: none"> <li>• Blackout: The screen displays a black image.</li> <li>• Previous Frame: The screen always displays the last frame.</li> </ul>

### 7.4.4.7 Configure Ethernet Port Backup

Test whether the pre-stored images, backup Ethernet ports and devices take effect without plugging and unplugging the Ethernet cables.

#### Prerequisites

The pre-stored images, primary and backup Ethernet ports or primary and backup devices have been configured.

#### Notes

None

#### Interface Example

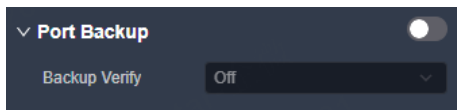

#### Description

On the **Cabinet Properties** tab interface, configure the following parameters.

Parameter	Description
Port Backup	Turn on or turn off the function. <ul style="list-style-type: none"> <li>• : On</li> <li>• : Off</li> </ul>
Backup Verify	Select the desired backup test. <ul style="list-style-type: none"> <li>• Off: Enable the output of all the Ethernet ports on the current device to complete the test.</li> <li>• Backup: Disable the output of the primary Ethernet port on the current device to test whether the backup port or device takes effect.</li> <li>• Primary: Disable the output of the backup Ethernet port on the current device to test whether the output of the primary port is normal.</li> <li>• Disconnect All: Disable the output of all the Ethernet ports on the current device to test whether the pre-stored image takes effect.</li> </ul>

 Note

After enabling Ethernet port backup, a  icon is displayed between the primary and backup ports in the Ethernet port list. By default, the first half of the ports serve as backups for the second half.

### 7.4.4.8 Set Dual RV Cards Backup

Receiving card backup allows you to set the backup relationship between two receiving cards. If the primary receiving card link fails, the backup one will take over the responsibilities of the primary receiving card and continue to work well to ensure the LED screen will not go black.

#### Prerequisites

Two receiving cards are connected to the cabinet.



#### Notes

When you enable both the device backup and dual receiving cards backup, the former takes precedence over the latter. When the layer sources of two devices are disconnected, the device will switch to the backup receiving card link.

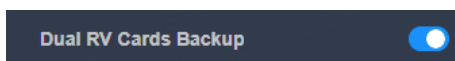
#### Interface Example



#### Description

Parameter	Description
Dual RV Cards Backup	Turn on or turn off the function. <ul style="list-style-type: none"> <li>• : On</li> <li>• : Off</li> </ul>

## 7.5 Screen Correction

### 7.5.1 Correct Seams

Adjust the seams between cabinets or modules to improve the display effect.

#### Prerequisites

You have configured the cabinets.

#### Notes

None

#### Description

Step 1 Select **Correction** at the top of the page.

Figure 7-22 Screen correction

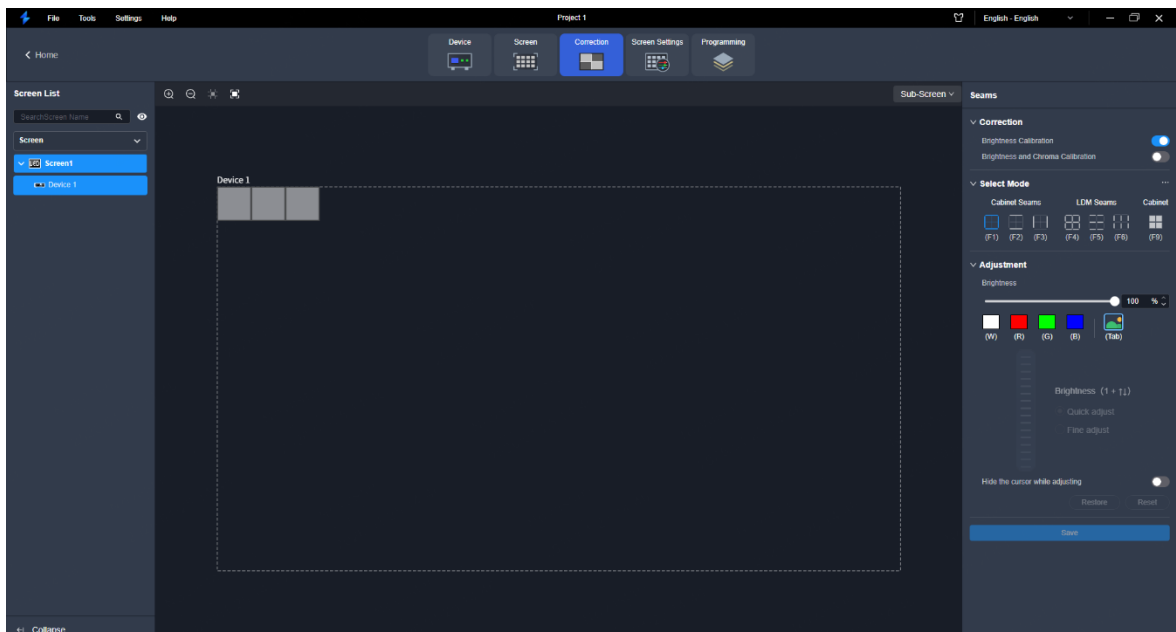



Step 2 On the **Seams** tab in the properties area, toggle the **Brightness Calibration** switch to .

 Note

- Only the specific receiving cards support the **Seam Correction** switch, including the A8s Pro, NV7508, NV7512, NV7516, DH7508-S, DH7512-S, DH7516-S and MRV208-NB7s. The adjustment of bright and dark lines can be controlled independently of the coefficients. When turned off, the bright and dark lines cannot be adjusted, and any previously made adjustments will not be displayed.
- Apart from the above-mentioned receiving cards, the **Seam Correction** switch will not be displayed on this interface. In this case, simply toggling on the **Brightness Calibration** or **Brightness and Chroma Calibration** will ensure that the seam correction takes effect.

Step 3 Toggle on **Brightness Calibration** or **Brightness and Chroma Calibration** to view the correction effect.

- **Brightness Calibration**: Set the **Brightness Calibration** switch to  to make the screen apply the calibration effect made by the calibration platform.
- **Brightness and Chroma Calibration**: Set the **Brightness and Chroma Calibration** switch to  to make the screen apply the calibration effect made by the calibration platform.

The **Brightness Calibration** and **Brightness and Chroma Calibration** are mutually exclusive.

Figure 7-23 Correction (seams)

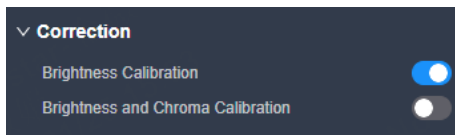

Step 4 Select a correction mode.

Figure 7-24 Select mode (seams)

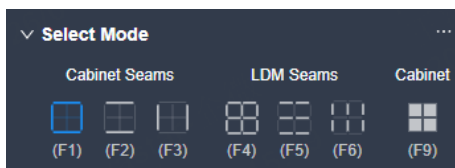

- **Cabinet Seams**: Correct the seams of cabinets.
- **LDM Seams**: Correct the seams of modules.

 Note

You can use the corresponding shortcut keys to quickly select the target one. For example, press F1 to select all outer border lines of the cabinet.

Step 5 When correcting the module seams, if you need to override the numbers of module columns and rows, click the  icon next to **Select Mode** and then perform the settings on the **Cabinet Structure Override** window. Otherwise, skip this step.

Figure 7-25 Cabinet structure override



Step 6 Set the screen display parameters and check the seam correction effect.

Figure 7-26 Adjustment (4-color)

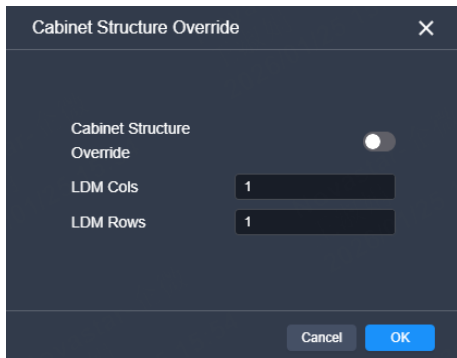
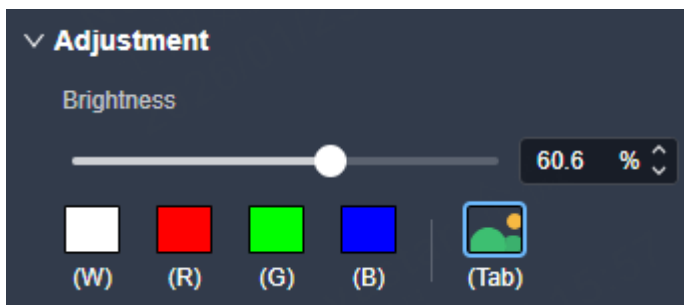

- Brightness: Adjust the display brightness.
- Display image: Set the image displayed on the screen. By default, the current input source is being displayed () . You can switch to a monochrome display.

 Note

You can use the corresponding shortcut keys to switch between various images. For example, press **W** to switch to white image display.

Step 7 In the topology area, click or click and drag the mouse to select the seams to be corrected.

Step 8 Set the adjustment parameters.

Figure 7-27 Set the parameters

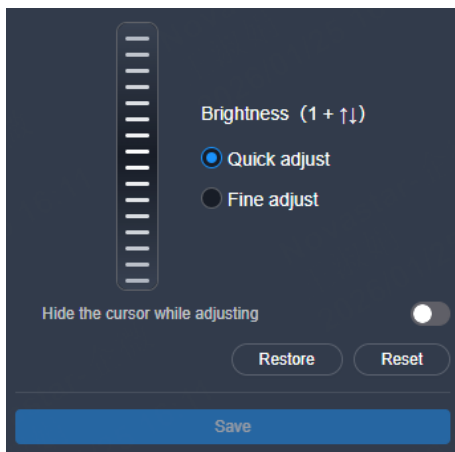

- Quick adjust: Has a large range of adjustment.
- Fine Adjust: Has a fine range of adjustment.
- Hide the cursor while adjusting: When this is enabled () , the cursor will not be displayed on the screen while adjusting brightness and chroma.

Step 9 Place the mouse on the scroll wheel icon and adjust the brightness by dragging the wheel icon up or down, scrolling the mouse wheel, or using the keyboard shortcuts **1+ ↑ / ↓**.

- Restore: Restore the configuration to the last saved.
- Reset: Reset the configuration to factory defaults.

Step 10 After the settings, click **Save**.

## 7.5.2 Erase Seam Correction

If there are any changes made to the cabinets, such as moving a receiving card from one cabinet to another or replacing the cabinet module, it may cause bright or dark lines that had been previously corrected to appear in the middle of the cabinet or module. In such cases, you have the option to remove the seam correction that was applied.

### Prerequisites

You have configured the cabinets.

### Notes

None

## Description

Step 1 Select **Correction** at the top of the page.

Step 2 Select the **Cabinet** mode.

Figure 7-28 Select mode (cabinet)

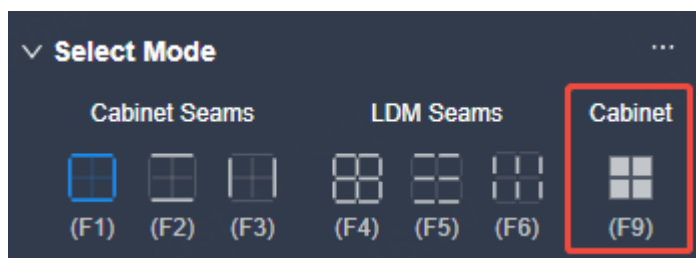

Step 3 Select the target cabinets and then click **Erase** to remove the seam correction that was applied to them. The erasure will be automatically saved to the hardware once you are done.

Figure 7-29 Erase seam correction

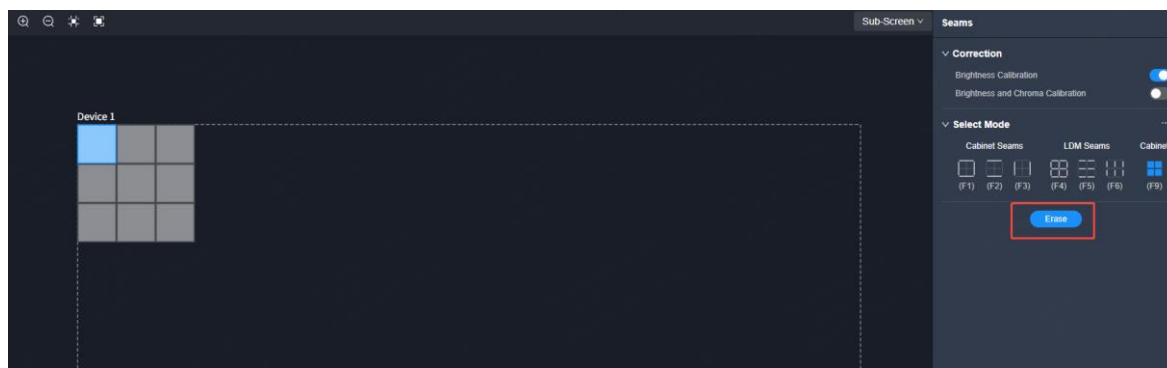

## 7.6 Screen Settings

### 7.6.1 Adjust Image Quality

#### 7.6.1.1 Adjust Brightness and Gamma

Adjust the Gamma value and brightness of the output to enhance the overall image quality of the LED screen.

#### Prerequisites

None

## Notes

None

## Interface Example

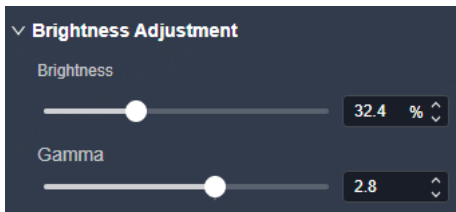

## Description

Select **Screen Settings** at the top of the page, and then on the **Image Quality** tab interface, configure the following parameters.

Parameter	Description
Brightness	The brightness of the LED screen
Gamma	Adjust the ratio of the screen brightness to the input level. The parameters are read from the receiving card, which default to optimal values at the factory. It is recommended the parameter adjustment be carried out by the trained personnel when necessary.

### 7.6.1.2 Set LED Image Booster

Set the LED Image Booster function to improve the delicacy and accuracy of the image color and gradation and realize free switching of the display color gamut.

## Prerequisites

Before the operation, color gamut and brightness correction by using the CA410-VP427, CA410-P427 or CA410-P427H colorimeter must be done.



## Notes

None

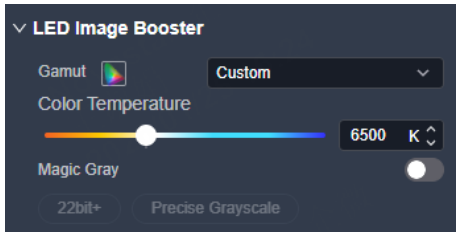
## Interface Example



## Description

Parameter	Description
Gamut	<p>The color gamut standard</p> <p>The output gamut options include standard gamuts, custom gamuts, the original screen gamut and the input gamut (<b>From input</b>).</p> <p>To set the custom gamut, click , select a gamut in the properties area on the color gamut diagram, and adjust the red, green, blue and white parameters based on the selected gamut.</p>
Color Temperature	Drag the slider to adjust color temperature.
Magic Gray	<p>Turn on or turn off the function.</p> <ul style="list-style-type: none"> <li>• : On</li> <li>• : Off</li> </ul>

### 7.6.1.3 Adjust EOTF

#### Prerequisites

None

#### Notes

The supported adjustment parameters depend on the HDR source settings.

## Interface Example

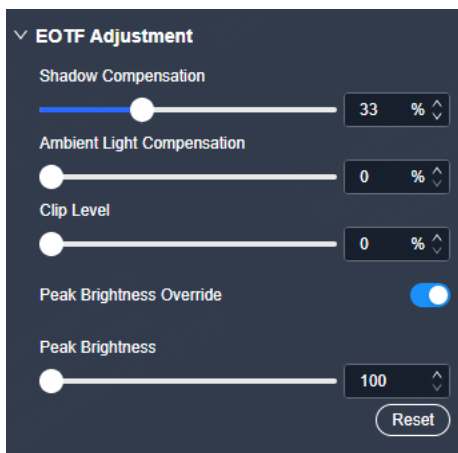

## Description

On the **Image Quality** tab interface, drag the sliders to adjust the related parameters.

Parameter	Description
Shadow Compensation	Adjust this parameter to enhance the image display effect. The greater the value, the clearer the details in the shadow area. Range: 0 to 100 (default: 33), Step: 1
Ambient Light Compensation	Adjust this parameter to reduce the loss of image details caused by ambient light diffusion. Range: 0 (default) to 80 , Step: 1
Clip Level	Adjust the parameter to reduce the screen overexposure and enhance details of the highlight areas. Range: 0 (default) to 100 , Step: 1
Override Peak Screen Brightness	Turn on or turn off the function. <ul style="list-style-type: none"> <li>• On: <input checked="" type="checkbox"/></li> <li>• Off: <input type="checkbox"/></li> </ul>
Peak Screen Brightness	Adjust the brightness of the screen when it is functioning normally. When <b>Override Peak Screen Brightness</b> is enabled, this parameter can be adjusted. Range: 100 to 10000 nits (default: 1000 nits), Step: 1

## 7.6.2 Adjust Output

### 7.6.2.1 Set Output Bit Depth

#### Prerequisites

None

#### Notes

When you use the HDR function, setting output bit depth to 10bit is required to achieve optimal display effect.

#### Interface Example

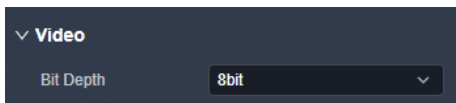

#### Description

On the **Output** tab interface, configure the following parameters.

Parameter	Description
Bit Depth	Set the output bit depth. The supported options include <b>8bit</b> and <b>10bit</b> .

### 7.6.2.2 Configure 3D

Directly connect a third-party 3D emitter using the device's built-in 3D connector, or connect to the EMT200 Pro emitter via the device's Ethernet port. Then, use the compatible 3D glasses to achieve a 3D display effect.

#### Prerequisites

- Video source format: Side-by side, top-and-bottom or frame sequential

- When paired with the EMT200 Pro, it is recommended to use a 3D source of 60Hz to enjoy an optimal experience.

## Notes



- When the 3D function is enabled and the video source format is **Side-by-Side** or **Top-and-Bottom**, the device output capacity will be halved.
- When the 3D function is enabled and the video source format is **Frame Sequential**, you need to manually set the output frame rate which must be the same as the input frame rate.
- The 3D function and input cropping cannot be enabled at the same time.
- After enabling the 3D function on the **Screen Settings** page, 3D switches of all the layers will be toggled on. If you want to use a 2D layer, please toggle off the 3D switch of the desired layer in the property area of the **Programming** page.
- The 3D effect follows the layer. The output area where a 3D layer is located always displays the 3D effect.



## Interface Example



## Description

On the **Output** tab interface, configure the following parameters.

Parameter	Description
3D	Turn on or turn off the 3D function. <ul style="list-style-type: none"> <li>• : On</li> <li>• : Off</li> </ul>
Source Format	The format of the 3D video source Set the format to <b>Side-by-Side</b> , <b>Top-and-Bottom</b> or <b>Frame Sequential</b> according to the format of the accessed video source.
Eye Priority	Set which image is sent first, the right eye image or the left eye image. Put on the 3D glasses to view the screen. If the display appears abnormal, adjust the

Parameter	Description
	parameter value to the other one. If the display is normal, no further adjustments are needed.
3rd Emitter	Turn on or turn off the function. <ul style="list-style-type: none"> <li>• : On</li> <li>• : Off</li> </ul>
Signal Delay	Set the delay time of sending the synchronization signal from the 3D signal emitter to the 3D glasses. This setting ensures that the switching between left and right eye images of the 3D glasses is in sync with the switching between the left and right eye images on the screen. This parameter is applicable to both the NovaStar and third-party emitters.

### 7.6.2.3 Check Load

Check the capacity usage of each Ethernet port of the device.

#### Prerequisites

None

#### Notes

None

#### Interface Example



#### Description

On the **Output** tab interface, click  next to the device information to check the usage of the device loading capacity.

## 7.7 Layer Operations

### 7.7.1 Add Layers

Add layers to screen

#### Prerequisites

Make sure the device is in **Video Controller** mode before adding layers.

#### Notes

The maximum number of layers that can be added depends on the connected device.

Device Model	Number of Supported Layers (2K×1K)
VX400 Pro	6
VX600 Pro	
VX1000 Pro	
VX2000 Pro	12

#### Description

- Step 1 Click **Programming** at the top of the page to enter the layer editing page. Select the desired screen from the left screen list, and then click the **Input** tab.

Figure 7-30 Programming (VX2000 Pro)

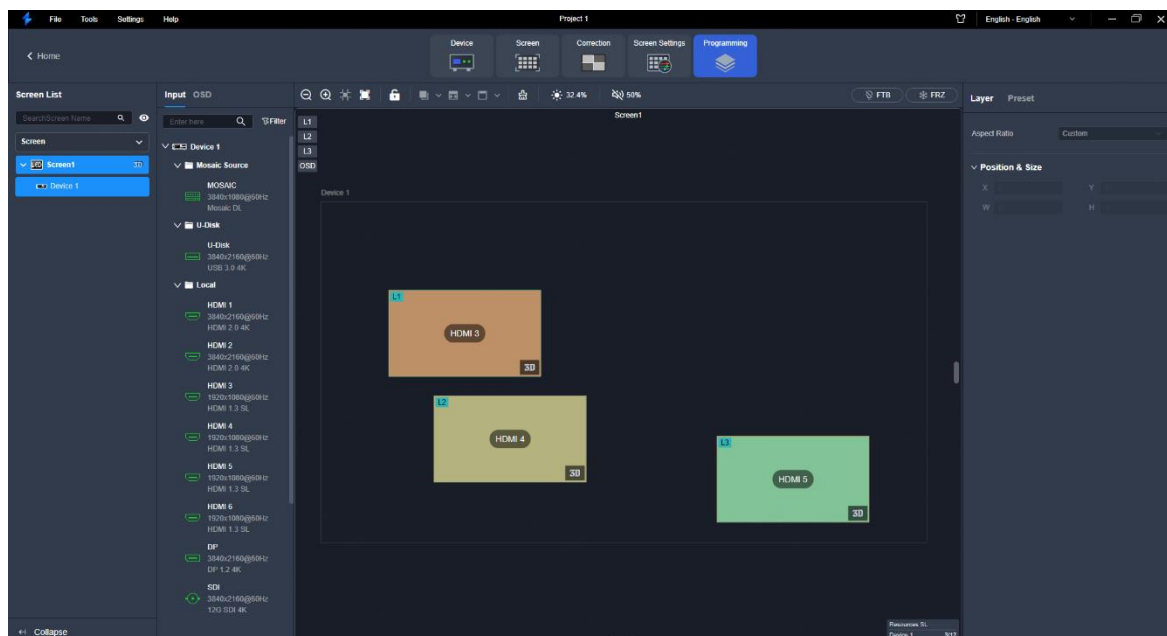

Step 2 Add the layers to the screen.

Drag an input source in the input list to the screen.

Step 3 Perform the desired layer operations as required.

Figure 7-31 Layer operations

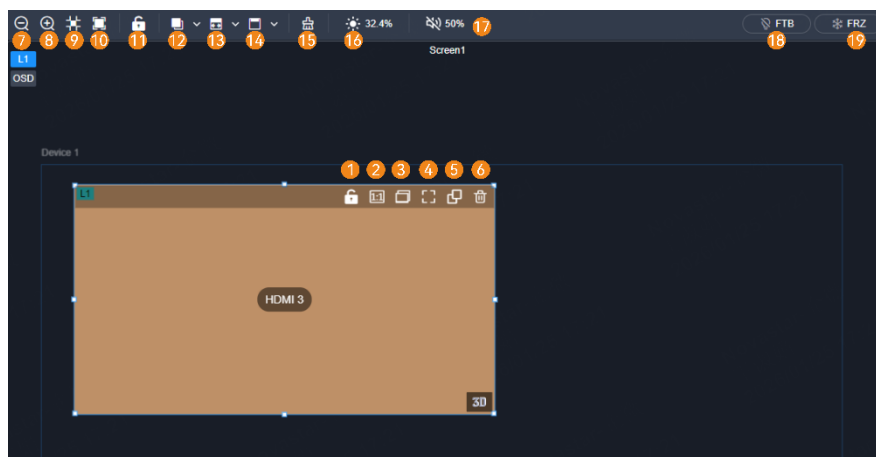

- 1 Lock/Unlock layer
- 2 Pixel-to-pixel display
- 3 Fill entire screen
- 4 Fill canvas
- 5 Follow canvas
- 6 Delete layer
- 7 Zoom Out
- 8 Zoom In
- 9 Zoom to Selection
- 10 Auto fit
- 11 Lock/Unlock canvas
- 12 Adjust layer priority
- 13 Set layer filling mode
- 14 Set layer alignment method
- 15 Clear
- 16 Output image brightness
- 17 Set audio
- 18 FTB
- 19 Freez/unfreeze

## 7.7.2 Configure Video Source Properties

In the input list, select an input source and set the relevant properties on the right pane. For detailed configurations and parameter descriptions, please refer to [Configure Input Properties](#).

## 7.7.3 Mosaic Source Settings

Both HDMI and OPT sources support mosaicing.

### 7.7.3.1 View Mosaic Source Info

View the basic properties of the mosaic source and change the source name.

#### Prerequisites

A mosaic source has been configured and its signal is fine.

#### Notes

None

#### Interface Example

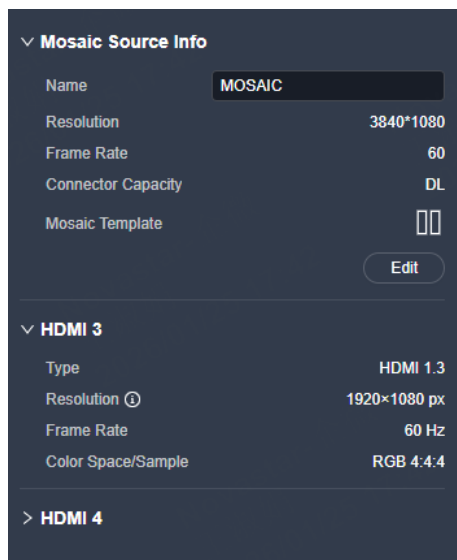

#### Description

On the **Mosaic Source** tab interface, type in a new source name and click anywhere else on the interface to save the change.

### 7.7.3.2 Configure Mosaic Sources

Set the mosaic source name, sub-source type, mosaic layout as well as sub-source size.

#### Prerequisites

None

#### Notes

Only the input sources of the same connector type support mosaicing, and the frame rates of sub-source must be the same.

#### Interface Example

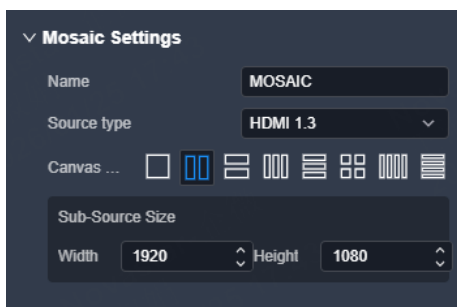

#### Description

On the **Edit Mosaic** tab interface, configure the following parameters.

Parameter Name	Description
Name	The name of the mosaic source
Source Type	The type of the sub-sources Config method: Select <b>HDMI 1.3</b> , <b>HDMI 2.0</b> or <b>OPT</b> from the drop-down list.
Layout	The layout of the mosaic source Config method: Select the desired layout from the standard layout template, and then drag the inputs in the input list to the sub-cells respectively.
Sub-Source Size	The size of the sub-sources <ul style="list-style-type: none"> <li>• Default width: 1920 pixels, max width: 8192 pixels</li> <li>• Default height: 1080 pixels, max height: 8192 pixels</li> </ul>

Parameter Name	Description
	<ul style="list-style-type: none"> <li>Max width and height: 4096×2160</li> </ul>

## 7.7.4 Configure USB Source Properties

Select a USB source in the input list and configure relevant properties on the **USB Playback Settings** tab interface.

The models of devices that support USB playback and the corresponding output resolutions for USB sources are listed below.

Device Model	USB Source Resolution
VX400 Pro	1920×1080@60Hz
VX600 Pro	
VX1000 Pro	
VX2000 Pro	3840×2160@60Hz

### 7.7.4.1 Play USB Files

#### Prerequisites

The U-DISK connector on the front panel is inserted with a USB drive which is successfully identified.

#### Notes

None

#### Interface Example

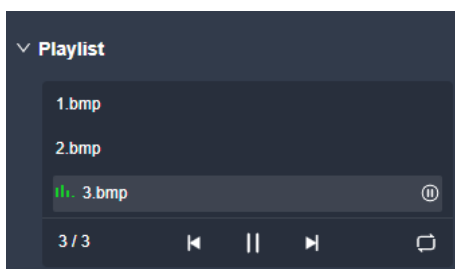

## Description

In the playlist, select a file to play it and you can also stop the playback, play the previous or next file as well as set the playback mode.

## 7.7.4.2 Configure Playback Parameters

### Prerequisites

The U-DISK connector on the front panel is inserted with a USB drive which is successfully identified.

### Notes

- Single-partition USB drive supported
- File system: NTFS, FAT32 and exFAT
- Max. width and height of media files  
Width: 3840 pixels, height: 2160 pixels
- Picture format: jpg, jpeg, png and bmp
- Decoded image resolution: 3840×2160 or lower
- Video format: mp4, mkv, mov, avi, flv, m4v, mpg, mpeg, ts
- Video coding: H.264, H.265, MPEG-2, MPEG-4
- Max. video frame rate:  
H.264: 3840×2160@30fps, H.265: 3840×2160@60fps  
MPEG-2/MPEG-4: 1920×1080@60fps
- Max bitrate:  
H.264/H.265: 100Mbps  
MPEG-2/MPEG-4: 50Mbps
- Audio coding: AAC, AC3, DTS, MP3, DVD, DVD\_LPCM, MP2, OPUS
- Audio sampling rate:  
opus: 24kHz, 48kHz  
Other formats: 22.05kHz to 94kHz



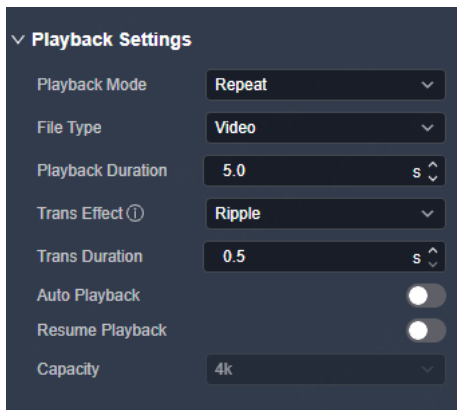

## Interface Example



## Description

On the **USB Playback Settings** tab interface, configure the following parameters.

Parameter	Description
Playback Mode	<p>The playback mode of the file</p> <ul style="list-style-type: none"> <li>• Repeat: Play the files in the playlist in order. Once the playback of the last file is completed, replay the first file.</li> <li>• Repeat in Order: Play the files in the playlist in order. Once the playback of the last file is completed, the screen will display a black image and the playback will stop.</li> <li>• Repeat One: Loop playback of the current file.</li> </ul>
File Type	<p>The type of the playback file</p> <ul style="list-style-type: none"> <li>• Video</li> <li>• Image</li> <li>• All: Videos and images</li> </ul> <p> <b>Note</b></p> <p>After the file type is selected, only the file of the selected type will be displayed in the playlist.</p>
Playback Duration	<p>The duration of the image playback</p> <p>The value ranges from 1 to 60 and it defaults to 5. (Unit: s)</p>
Trans Effect	<p>The trans effect of the image</p> <p>Supported trans effect: Ripple, zoom in, cut out, flip, blinds, H wipe, V wipe, cube, dissolve, grid, swapping, scroll, fade in/out, twirl, heart trans, doorway, perspective triangle, disappear, bounce, pinwheel and</p>

Parameter	Description
	random.
Trans Duration	The trans duration of the image The value ranges from 0.5 to 2 and it defaults to 0.5. (Unit: s)
Auto Playback	The auto playback switch Set whether to automatically play the USB files after the device is powered off and then power on with a USB drive inserted. <ul style="list-style-type: none"> <li> On If <b>Resume Playback</b> not enabled, replay the files in the playlist in order; If enabled, replay the file being played before power failure from the beginning.</li> <li> Off</li> </ul>
Resume Playback	Turn on or turn off the function. <ul style="list-style-type: none"> <li> On If a file is playing before the device power failure, enabling this function allows to replay the file from beginning after the device is powered on with a USB drive inserted.</li> <li> Off: Replay the files in the playlist in order.</li> </ul> <div style="background-color: #f0f0f0; padding: 5px; margin-top: 10px;">  <b>Note</b> <ul style="list-style-type: none"> <li>Enabling <b>Resume Playback</b> will also activate the <b>Auto Playback</b> feature at the same time.</li> <li>After <b>Resume Playback</b> is enabled, if the file being played before power failure cannot be found, the files will be played from the beginning of the playlist in order.</li> </ul> </div>

## 7.7.5 Set Audio

### Prerequisites

None

### Notes

None

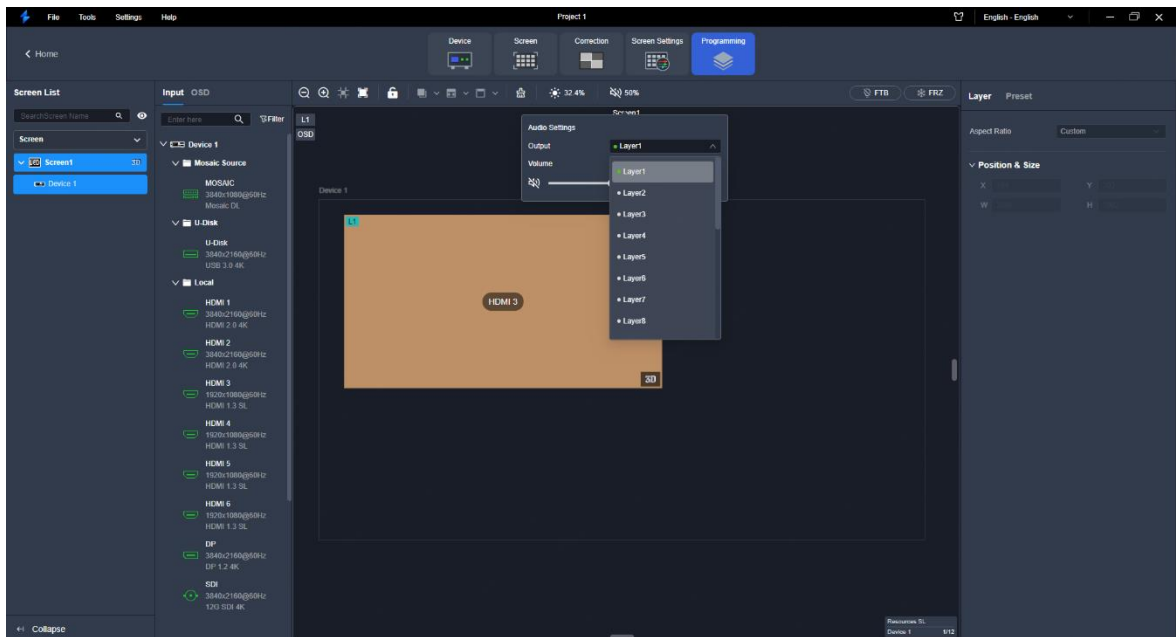

## Interface Example (VX2000 Pro)



## Description

On the **Programming** interface, hover the mouse over  and set the following parameters in the popup menu.

Parameter	Description
Output	<p>Set the output audio.</p> <ul style="list-style-type: none"> <li>• Layer n: Output the audio of the current layer input source. When you switch the current layer input source, the audio will also be changed.</li> <li>• Audio In: Output the analog audio coming from an external audio device. When you switch the current layer input source, the audio will not be changed.</li> <li>• Embedded audio of an input source: Output the fixed embedded audio. When you switch the current layer input source, the audio will not be changed.</li> </ul> <p>The supported input source types include HDMI sources, DP sources, and USB sources.</p> <p> <b>Note</b></p> <p>The input source audio of the layer 1 is output by default.</p>
Volume	<p>The output volume</p> <p>The value ranges from 0 to 100 and it defaults to 50%.</p>

Parameter	Description
	<ul style="list-style-type: none"> <li>• <b>0%</b>: Mute</li> <li>• <b>100%</b>: Output at maximum volume.</li> </ul> <p> Note</p> <p>Click  below <b>Volume</b> to enable or disable the audio.</p>

## 7.7.6 Set Input Source Audio

### Prerequisites

None

### Notes

None

### Interface Example (VX2000 Pro)

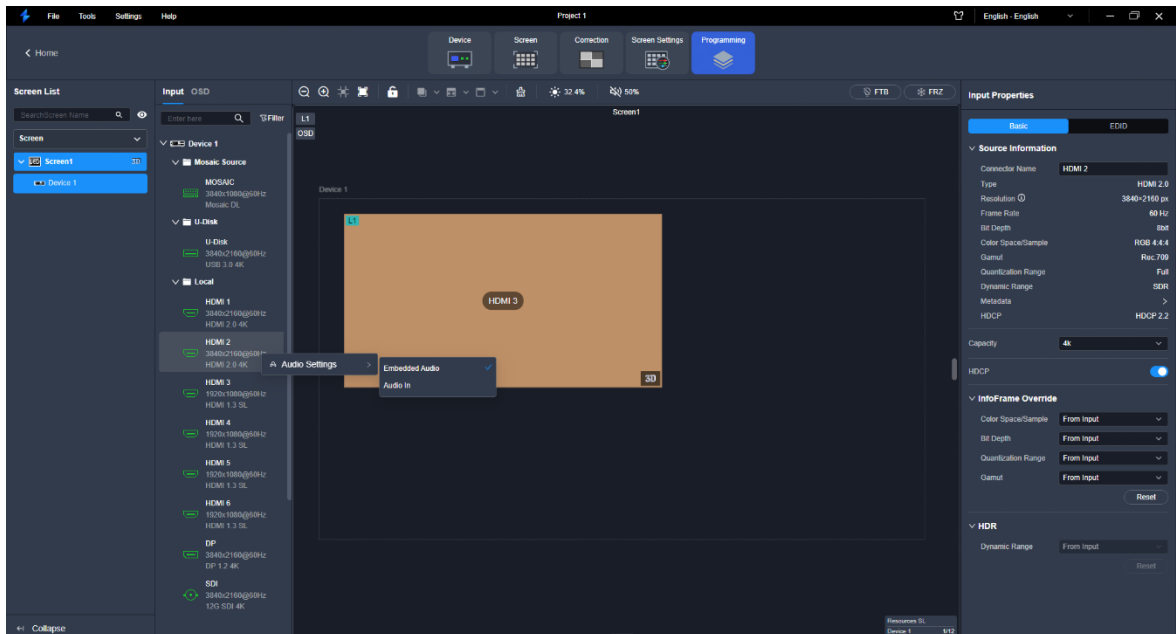

## Description

On the **Programming** interface, click the **Input** tab to display the input source list. Hover the mouse over the desired input source and click . In the popup menu, set the input source audio to **Embedded Audio** or **Audio In**.

## 7.7.7 Configure Layer Properties

Select the desired layer, and then set the layer-related properties in the property area on the right pane.

### 7.7.7.1 Configure Basic Properties

Configure the layer name, aspect ratio, position, size, as well as enabling the 3D effect.

## Prerequisites

None

## Notes

After enabling the 3D function on the **Screen Settings** page, 3D switches of all the layers will be toggled on. If you want to use a 2D layer, please toggle off the 3D switch of the desired layer in the property area of the **Programming** page.

## Interface Example

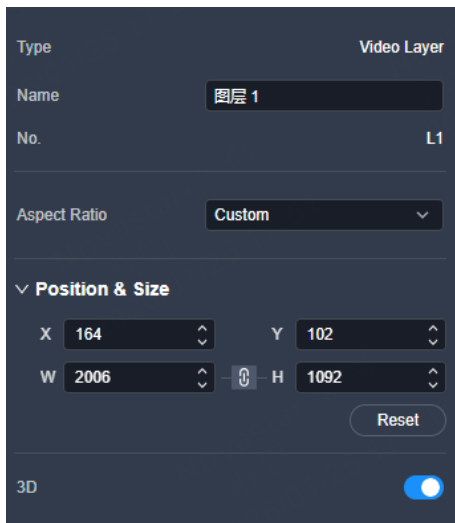

## Description

On the **Basic** tab interface, configure the following parameters.

Parameter	Description
Name	The layer name
Aspect Ratio	The ratio of the layer's width to its height After the aspect ratio is changed, the height of the layer remains unchanged, and the device automatically calculates its width.
X	The horizontal starting position of the layer on the screen The coordinates of the first pixel in the upper left corner of the screen are (0,0).
Y	The vertical starting position of the layer on the screen The coordinates of the first pixel in the upper left corner of the screen are (0,0).
W	The horizontal size of the layer The minimum width of a layer: 64 pixels
H	The vertical size of the layer The minimum height of a layer: 64 pixels
3D	Turn on or turn off the function <ul style="list-style-type: none"> <li>• <input checked="" type="checkbox"/>: On</li> <li>• <input type="checkbox"/>: Off</li> </ul>

### 7.7.7.2 Crop Layer Sources

When there are black borders or other redundant info in the input source image, the required picture can be retained through the cropping the input source, so as to improve the screen utilization.

#### Prerequisites

A fine signal is connected to the input connector.

#### Notes

- The status and capacity of the cropped source remain consistent with the original one.
- The input cropping and 3D functions cannot be enabled at the same time.

#### Interface Example

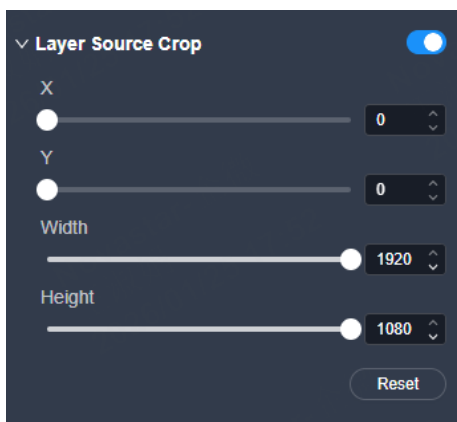

#### Description

On the **Advanced** tab interface, configure the following parameters.

Parameter	Description
Layer Source Crop	Turn on or turn off the function. <ul style="list-style-type: none"> <li>• : On</li> <li>• : Off</li> </ul>
X	The horizontal start position of the cropped area relative to the original source
Y	The vertical start position of the cropped area relative to the original source

Parameter	Description
Width	The number of horizontal pixels (width) of the cropped area
Height	The number of vertical pixels (height) of the cropped area

## 7.7.8 Configure OSD

Both the text OSD and image OSD are supported.

### Prerequisites

Before setting a time OSD or weather OSD, please ensure that the device is connected to the network to obtain the precise time and weather information.

### Notes

- The OSD locates at the top and its priority cannot be adjusted.
- The text OSD and image OSD cannot be enabled together.
- The OSD function and remote control function cannot be enabled together.

### OSD Type Descriptions

OSD Type	Description
Text OSD	<ul style="list-style-type: none"> <li>• Up to four text OSD presets are supported, and the preset 1 is selected by default. The quantity of the text components are as follows. <ul style="list-style-type: none"> <li>– Static text OSD: 10</li> <li>– Weather OSD: 2</li> <li>– Time OSD: 2</li> <li>– Dynamic text OSD: 1</li> </ul> </li> <li>• Does not support settings of the size and position of a text OSD.</li> </ul> <div style="background-color: #f0f0f0; padding: 5px; margin-top: 10px;">  <b>Note</b> The dynamic text OSD and other text components cannot be used together. </div>
Image OSD	<ul style="list-style-type: none"> <li>• Image gallery capacity: 75 MB</li> <li>• Supported image OSD formats: PNG/JPG/JPEG/BMP</li> <li>• Width and height limitations of a single image:</li> </ul>

OSD Type	Description
	<ul style="list-style-type: none"> <li>- VX400 Pro/VX600 Pro/VX1000 Pro: Max width × Max height ≤ 4096×1080, max width: 10240 pixels, max height: 8192 pixels</li> <li>- VX2000 Pro: Max width × Max height ≤ 4096×2160, max width: 16384 pixels, max height: 8192</li> </ul> <p>Note: If the max width and height limitations are exceeded, you need to scale or crop the image in Unico, and the width and height of the cropped should be greater than 64 pixels.</p> <ul style="list-style-type: none"> <li>• Supports setting of the image OSD position.</li> <li>• Does not support setting of the image OSD size.</li> <li>• Does not support setting of the image OSD opacity.</li> </ul>

### 7.7.8.1 Configure Text OSD

Step 1 In the screen list on the left, select the desired screen.

Step 2 Click the **OSD** tab.



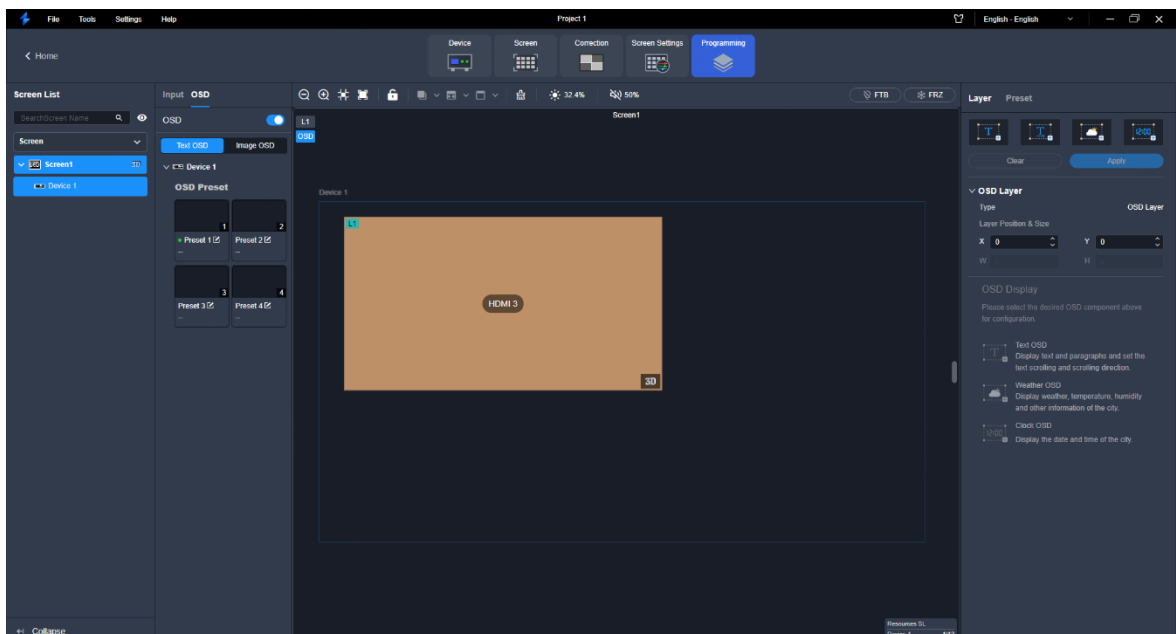

Step 3 Toggle the **OSD** switch to  to enable the OSD function.

Figure 7-32 Enable OSD



Step 4 Click the **Text OSD** tab, and drag the desired OSD preset to the editing area. The OSD preset 1 is selected by default.

OSD preset-related operations:

- Change the OSD preset name: Hover the mouse over the desired OSD preset, and then click  that appears. Enter a new preset name, and then click elsewhere in the interface to complete the preset name change.
- Clear the OSD preset: Click  at the top right corner of the desired preset, and then click **Yes** in the popup dialog box to clear OSD components saved in the selected preset.
- Lock/Unlock the OSD preset: Click  at the top right corner of the desired preset to lock or unlock the preset.
- Save the OSD preset: Click  at the top right corner of the desired preset, and then select another preset to save the OSD components from the original preset to the selected one.

Step 5 On the right **Layer** pane, drag the , ,  or  icon to add a static text OSD, dynamic text OSD, weather OSD or time OSD.

Step 6 Set the position and size of the OSD layer.

- X: Set the horizontal distance from the top left corner of the OSD layer to that of the screen.
- Y: Set the vertical distance from the top left corner of the OSD layer to that of the screen.
- W: Set the OSD layer width.
- H: Set the OSD layer height.

Step 7 Click the created OSD layer to display the OSD configuration area on the right.

Step 8 Set the related parameters of the added OSD component. For the parameters of each OSD component, please refer to the following descriptions.

Step 9 Click **Apply** at the top right corner to complete the settings and display the set OSD on the screen.

 Note

Select the desired OSD components, and then click  shown at the top right corner. In the popup dialog box, click **Yes** to delete the selected OSD component.

## Static Text OSD

Figure 7-33 Interface example

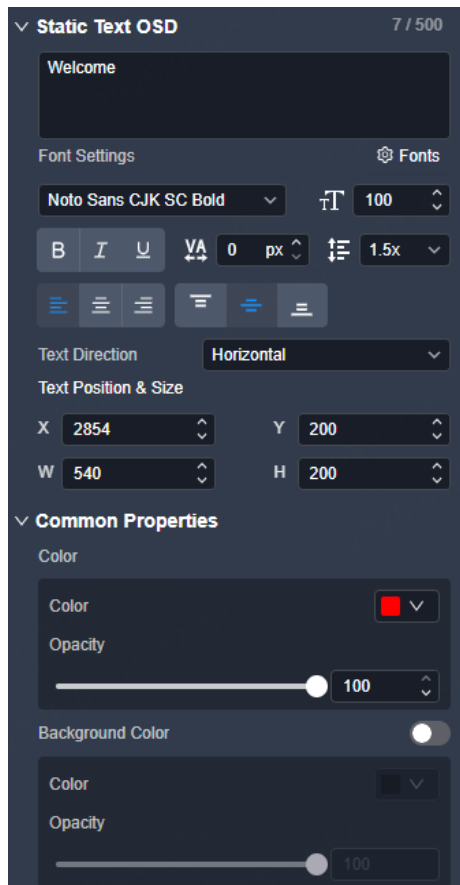













Table 7-3 Parameter descriptions

Area	Parameter	Description
Text area	-	Enter the text OSD content. The static text OSD supports multi-line display. You can press <b>Enter</b> on the keyboard to have line breaks.
Character	Font Settings	Select the desired text font from the drop-down list.
	Library	<ul style="list-style-type: none"> <li>• Delete single/multiple fonts: Click <b>Library</b>. In the popup window, check the boxes next to the desired fonts, and then click <b>Delete</b> to delete the selected fonts.</li> <li>• Delete all fonts: Click <b>Library</b>. In the popup window, check the box next to <b>Library</b>, and then click <b>Delete</b> to delete all fonts.</li> <li>• Add fonts: Click <b>Library</b>. In the popup window, click <b>New</b> to add the fonts saved in the local computer to the font library.</li> </ul>
	Font size	 : Set the font size. The value ranges from 8 to 512 px and it defaults to 100 px.

Area	Parameter	Description
	Font style	<ul style="list-style-type: none"> <li>: Make the text bold or not.</li> <li>: Italicize the text or not.</li> <li>: Underline the text or not.</li> </ul>
	Character spacing	 : Set the spacing between characters. The value ranges from 0 to 1000 px and it defaults to 0 px.
	Row spacing	 : Set the spacing between rows. This parameter is available when there are multiple rows. The value ranges from 0 to 1000 px and it defaults to 0 px.
	Alignment method	<p>Set the text alignment method.</p> <ul style="list-style-type: none"> <li>: Align the text content with the left margin of the display area.</li> <li>: Center the text content in the display area.</li> <li>: Align the text content with the right margin of the display area.</li> <li>: Align the text to the top of the display area.</li> <li>: Center the text vertically to the display area.</li> <li>: Align the text to the bottom of the display area.</li> </ul>
	Layout	<p>Select the text layout direction from the drop-down list.</p> <p>The supported options include <b>Horizontal</b>, <b>From Right (Vertical)</b> and <b>From Left (Vertical)</b>.</p>
	Text position and size	<p>Set the position and size of the OSD component.</p> <ul style="list-style-type: none"> <li>X: Set the horizontal distance from the top left corner of the OSD component to that of the screen.</li> <li>Y: Set the vertical distance from the top left corner of the OSD component to that of the screen.</li> <li>W: Set the OSD component width.</li> <li>H: Set the OSD component height.</li> </ul>
	Common properties	Text color
Background color		Toggle on/off <b>Background Color</b> to enable or disable the background color settings.

Area	Parameter	Description
		Click the color block icon next to <b>Select Color</b> to open a window where you can select the desired color or customize your own color. Drag the slider or enter a value in the text box to adjust the opacity. The opacity ranges from 0% (totally transparent) to 100% (nontransparent).

## Dynamic Text OSD

Figure 7-34 Interface example

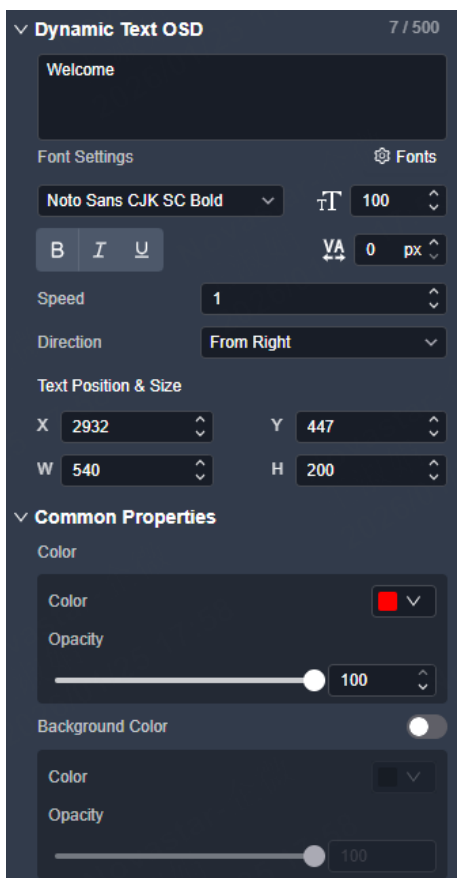







Table 7-4 Parameter description

Area	Parameter	Description
Text area	-	Enter the text OSD content.
Character	Font Settings	Select the desired text font from the drop-down list.
	Library	<ul style="list-style-type: none"> <li>Delete single/multiple fonts: Click <b>Library</b>. In the popup window, check the boxes next to the desired fonts, and then click <b>Delete</b> to delete the selected fonts.</li> <li>Delete all fonts: Click <b>Library</b>. In the popup window, check the</li> </ul>

Area	Parameter	Description
		<p>box next to <b>Library</b>, and then click <b>Delete</b> to delete all fonts.</p> <ul style="list-style-type: none"> <li>• Add fonts: Click <b>Library</b>. In the popup window, click <b>New</b> to add the fonts saved in the local computer to the font library.</li> </ul>
	Font size	<p>: Set the font size. The value ranges from 8 to 512 px and it defaults to 100 px.</p>
	Font style	<ul style="list-style-type: none"> <li>• : Make the text bold or not.</li> <li>• : Italicize the text or not.</li> <li>• : Underline the text or not.</li> </ul>
	Character spacing	<p>: Set the spacing between characters. The value ranges from 0 to 1000 px and it defaults to 0 px.</p>
	Speed	Set the text scrolling speed. The value ranges from 0 (static) to 10 (fastest).
	Direction	<p>Set the text scrolling direction.</p> <ul style="list-style-type: none"> <li>• From Left: The text scrolls from right to left in the display area.</li> <li>• From Right: The text scrolls from left to right in the display area.</li> </ul>
	Text position and size	<p>Set the position and size of the OSD component.</p> <ul style="list-style-type: none"> <li>• X: Set the horizontal distance from the top left corner of the OSD component to that of the screen.</li> <li>• Y: Set the vertical distance from the top left corner of the OSD component to that of the screen.</li> <li>• W: Set the OSD component width.</li> <li>• H: Set the OSD component height.</li> </ul>
Common properties	Text color	Click the color block icon next to <b>Select Color</b> to open a window where you can select the desired color or customize your own color. Drag the slider or enter a value in the text box to adjust the opacity. The opacity ranges from 0% (totally transparent) to 100% (nontransparent).
	Background color	<p>Toggle on/off <b>Background Color</b> to enable or disable the background color settings.</p> <p>Click the color block icon next to <b>Select Color</b> to open a window where you can select the desired color or customize your own color. Drag the slider or enter a value in the text box to adjust the opacity. The opacity ranges from 0% (totally transparent) to 100% (nontransparent).</p>

## Weather OSD

Figure 7-35 Interface example

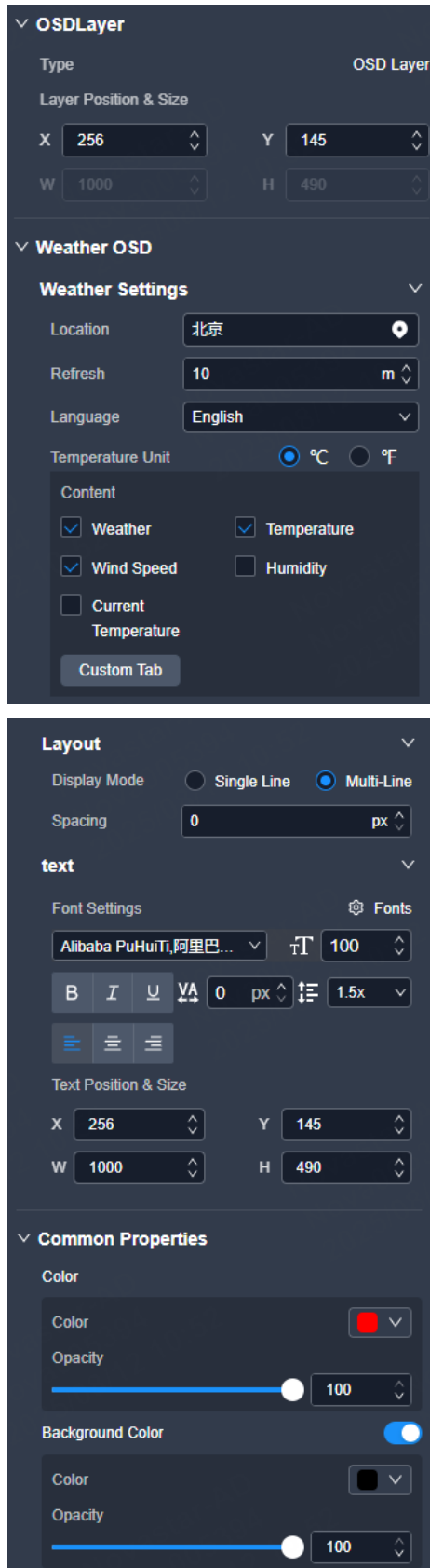











Table 7-5 Parameter description

Area	Parameter	Description
Weather settings	Location	Click  to open the map window, where you can select the desired location or enter the address. Click <b>OK</b> to complete the settings.
	Refresh	Set the automatic refresh interval for the weather information. The value ranges from 1 to 1440 minutes and it defaults to 10 minutes.
	Language	Set the text language. The supported options include English and Chinese.
	Temperature Unit	Set the temperature unit. The supported options include <b>°C</b> and <b>°F</b> .
	Content	Set the content to be displayed in the weather OSD. Check the box next to the desired content to display it in the weather OSD. You can also click <b>Custom Tab</b> to edit the default display content.
Layout	Display mode	Set the display mode of the weather OSD. <ul style="list-style-type: none"> <li>• Single Line: Display all items in single line.</li> <li>• Multi-Line: Display each item in single-line.</li> </ul>
	Spacing	Set the spacing between each selected content in <b>Single Line</b> display mode or set the spacing between rows in <b>Multi-Line</b> display mode.
Text	Font Settings	Select the desired text font from the drop-down list.
	Library	<ul style="list-style-type: none"> <li>• Delete single/multiple fonts: Click <b>Library</b>. In the popup window, check the boxes next to the desired fonts, and then click <b>Delete</b> to delete the selected fonts.</li> <li>• Delete all fonts: Click <b>Library</b>. In the popup window, check the box next to <b>Library</b>, and then click <b>Delete</b> to delete all fonts.</li> <li>• Add fonts: Click <b>Library</b>. In the popup window, click <b>New</b> to add the fonts saved in the local computer to the font library.</li> </ul>
	Font size	 : Set the font size. The value ranges from 8 to 512 px and it defaults to 100 px.
	Font style	<ul style="list-style-type: none"> <li>• : Make the text bold or not.</li> <li>• : Italicize the text or not.</li> <li>• : Underline the text or not.</li> </ul>
	Character spacing	 : Set the spacing between characters. The value ranges from 0 to 1000 px and it defaults to 0 px.

Area	Parameter	Description
	Row spacing	 : Set the spacing between rows. This parameter is available when there are multiple rows. The value ranges from 0 to 1000 px and it defaults to 0 px.
	Alignment method	<ul style="list-style-type: none"> <li>• : Align the text content with the left margin of the display area.</li> <li>• : Center the text content in the display area.</li> <li>• </li> </ul>
	Text position and size	<p>Set the position and size of the OSD component.</p> <ul style="list-style-type: none"> <li>• X: Set the horizontal distance from the top left corner of the OSD component to that of the screen.</li> <li>• Y: Set the vertical distance from the top left corner of the OSD component to that of the screen.</li> <li>• W: Set the OSD component width.</li> <li>• H: Set the OSD component height.</li> </ul>
Common properties	Text color	Click the color block icon next to <b>Select Color</b> to open a window where you can select the desired color or customize your own color. Drag the slider or enter a value in the text box to adjust the opacity. The opacity ranges from 0% (totally transparent) to 100% (nontransparent).
	Background color	<p>Toggle on/off <b>Background Color</b> to enable or disable the background color settings.</p> <p>Click the color block icon next to <b>Select Color</b> to open a window where you can select the desired color or customize your own color. Drag the slider or enter a value in the text box to adjust the opacity. The opacity ranges from 0% (totally transparent) to 100% (nontransparent).</p>

## Time OSD

Figure 7-36 Interface example

The screenshot displays the configuration interface for the Time OSD. It is organized into four main sections:

- OSD Layer:** Includes 'Type' (OSD Layer) and 'Layer Position & Size' with input fields for X (163), Y (241), W (1720), and H (200).
- Configuration:** Includes 'Time Zone' (UTC+08:00 Asia/Shang...) and 'Time Offset' (0 h).
- Content:** Includes 'Language' (English), 'Date' (toggle on), 'Year Format' (YYYY), 'Date Format' (YYYY/MM/DD), 'Time Type' (Local Time), 'Week' (toggle on), 'Time' (toggle on), '24-Hour' (toggle off), and 'Time Format' (HH:MM:SS).
- Layout:** Includes 'Display Mode' (Single Line selected, Multi-Line unselected) and 'Spacing' (0 px).

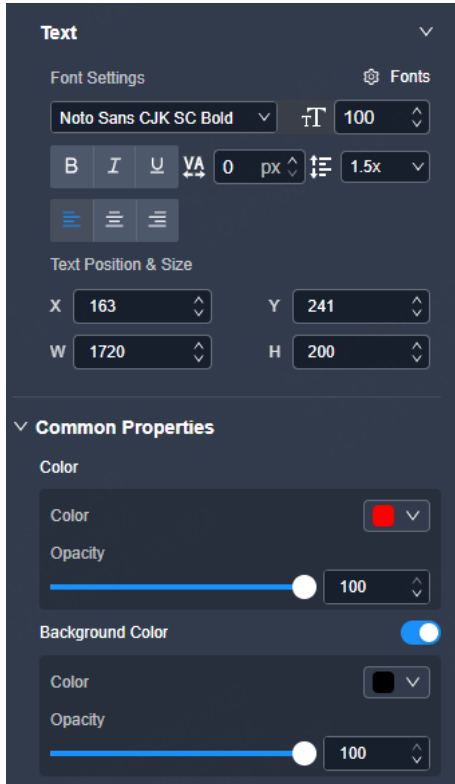















Table 7-6 Parameter descriptions

Area	Parameter	Configuration
Configuration	Time zone	Select the time zone from the drop-down list.
	Time offset	Set the time offset value. The value ranges from -2 to +2 (unit: hour).
Content	Language	Set the text language. The supported options include English and Chinese.
	Date	Display or hide the date. <ul style="list-style-type: none"> <li><input checked="" type="checkbox"/>: Display the date.</li> <li><input type="checkbox"/>: Hide the date.</li> </ul>
	Year format	Set the year format. The supported options include YYYY (four-digit year) and YY (two-digit year).
	Date format	Set the date format.
	Time type	The supported options include <b>Local Time</b> and <b>Network Time</b> .
	Week	Display or hide the week. <ul style="list-style-type: none"> <li><input checked="" type="checkbox"/>: Display the week.</li> <li><input type="checkbox"/>: Hide the week.</li> </ul>
	Time	Display or hide the time.

Area	Parameter	Configuration
		<ul style="list-style-type: none"> <li>: Display the time.</li> <li>: Hide the time.</li> </ul>
	24-hour	Display the time with 24-hour format or not. <ul style="list-style-type: none"> <li>: Display the time with 24-hour forma</li> <li>: Display the time with 12-hour forma</li> </ul>
	Time Format	Set the time format.
Layout	Display mode	Set the display mode of the time OSD. <ul style="list-style-type: none"> <li>Single-Line: Display the date, day of the week and time in single-line.</li> <li>Multi-Line: Display each item in single-line.</li> </ul>
	Spacing	Spacing: Set the spacing between the date, day of the week and time in <b>Single Line</b> display mode or set the spacing between rows in <b>Multi-Line</b> display mode.
Text	Font Settings	Select the desired text font from the drop-down list.
	Library	<ul style="list-style-type: none"> <li>Delete single/multiple fonts: Click <b>Library</b>. In the popup window, check the boxes next to the desired fonts, and then click <b>Delete</b> to delete the selected fonts.</li> <li>Delete all fonts: Click <b>Library</b>. In the popup window, check the box next to <b>Library</b>, and then click <b>Delete</b> to delete all fonts.</li> <li>Add fonts: Click <b>Library</b>. In the popup window, click <b>New</b> to add the fonts saved in the local computer to the font library.</li> </ul>
	Font size	 : Set the font size. The value ranges from 8 to 512 px and it defaults to 100 px.
	Font style	<ul style="list-style-type: none"> <li>: Make the text bold or not.</li> <li>: Italicize the text or not.</li> <li>: Underline the text or not.</li> </ul>
	Character spacing	 : Set the spacing between characters. The value ranges from 0 to 1000 px and it defaults to 0 px.
	Row spacing	 : Set the spacing between rows. This parameter is available when there are multiple rows. The value ranges from 0 to 1000 px and it defaults to 0 px.
	Alignment method	<ul style="list-style-type: none"> <li>: Align the text content with the left margin of the display area.</li> <li>: Center the text content in the display area.</li> </ul>

Area	Parameter	Configuration
		<ul style="list-style-type: none"> <li>• </li> </ul>
	Text position and size	<p>Set the position and size of the OSD component.</p> <ul style="list-style-type: none"> <li>• X: Set the horizontal distance from the top left corner of the OSD component to that of the screen.</li> <li>• Y: Set the vertical distance from the top left corner of the OSD component to that of the screen.</li> <li>• W: Set the OSD component width.</li> <li>• H: Set the OSD component height.</li> </ul>
Common properties	Text color	<p>Click the color block icon next to <b>Select Color</b> to open a window where you can select the desired color or customize your own color. Drag the slider or enter a value in the text box to adjust the opacity. The opacity ranges from 0% (totally transparent) to 100% (nontransparent).</p>
	Background color	<p>Toggle on/off <b>Background Color</b> to enable or disable the background color settings.</p> <p>Click the color block icon next to <b>Select Color</b> to open a window where you can select the desired color or customize your own color. Drag the slider or enter a value in the text box to adjust the opacity. The opacity ranges from 0% (totally transparent) to 100% (nontransparent).</p>

## 7.7.8.2 Configure Image OSD

### Add Image OSDs

- Step 1 In the screen list on the left, select the desired screen.
- Step 2 Click the **OSD** tab.
- Step 3 Toggle the **OSD** switch to  to enable the OSD function.

Figure 7-37 Enable OSD



- Step 4 Click the **Image OSD** tab to enter the image OSD configuration page.
- Step 5 Click  to open a window where you can select the desired OSD images.
- Step 6 Click **Open** to upload the selected images.
- Step 7 Click and drag the uploaded image to the editing area to add an image OSD.

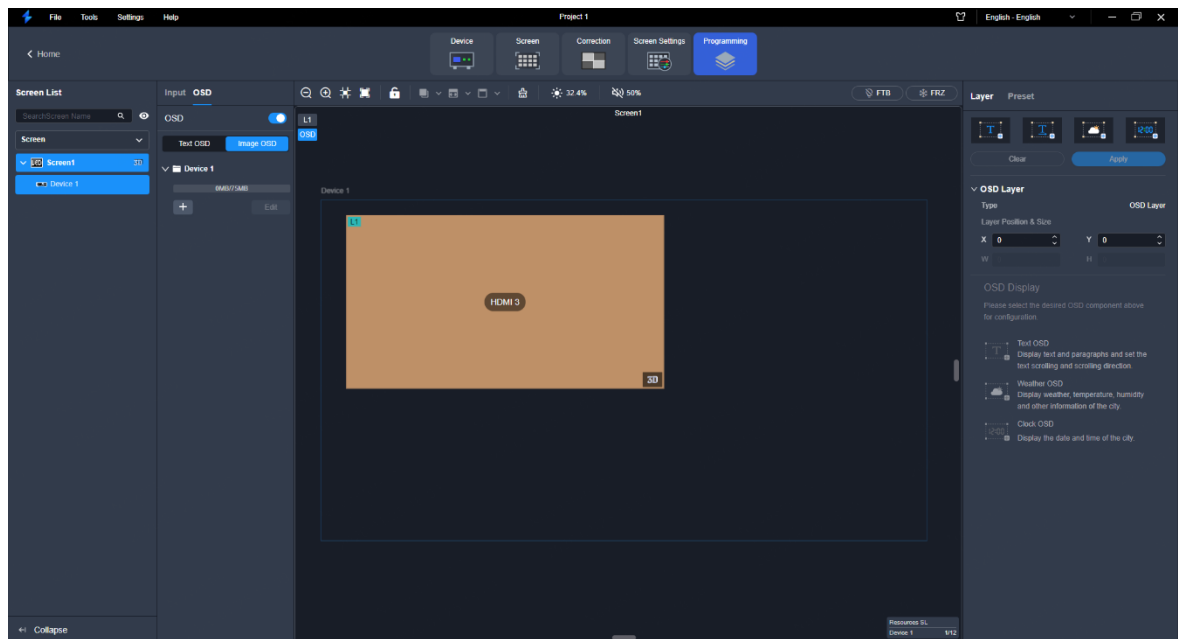

Figure 7-38 Add image OSDs

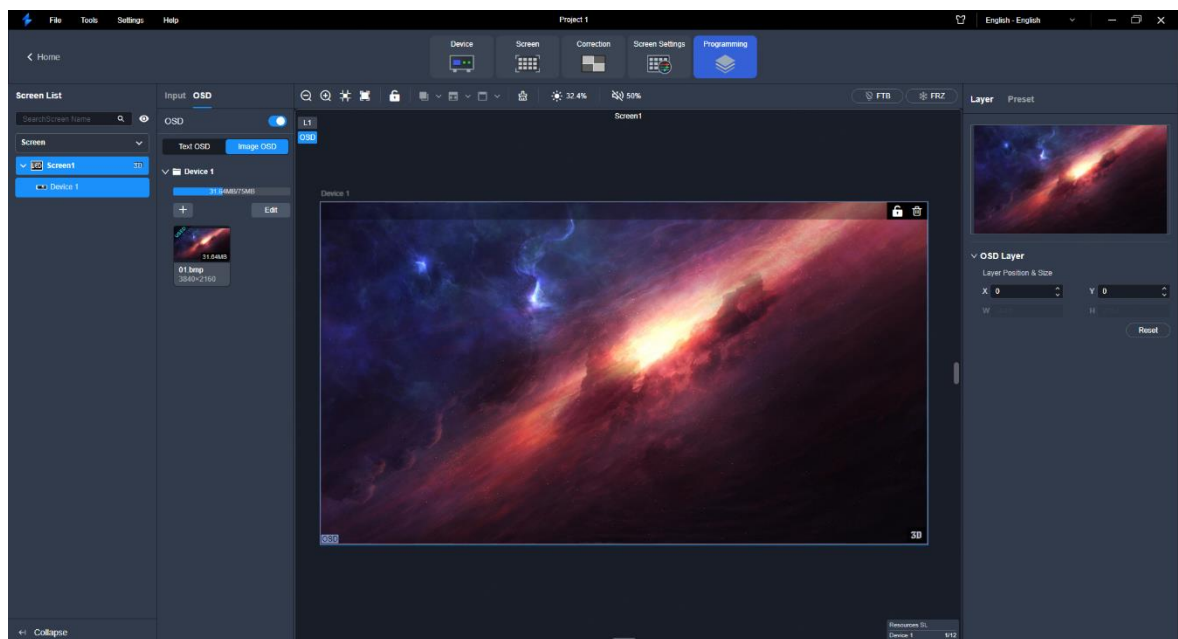

- Step 8 Set the position and size of the OSD layer.
  - X: Set the horizontal distance from the top left corner of the OSD layer to that of the screen.

- Y: Set the vertical distance from the top left corner of the OSD layer to that of the screen.

## Delete Gallery Images

- Delete a single image: Hover the mouse over the desired image, and then click . In the popup dialog box, select **Yes** to delete the selected image.
- Delete multiple images: Click **Edit**, and then check the boxes next to the desired image or check the box next to **All**. After selection, click  and select **Yes** in the popup dialog box.

## Export Gallery Images

Click **Edit**, and then click . In the popup window, select the saving path to export all images in the gallery to your local computer.

## 7.7.9 Manage Presets

To manage the presets, click **Preset** on the right side of the **Programming** interface and perform the corresponding actions as needed.

### Save Presets

- Step 1 In the screen list on the left, select the desired screen.
- Step 2 On the **Preset** tab interface, click **Add** at the bottom, and the system will automatically display the preset number binding window.

Figure 7-39 Bind presets (VX2000 Pro)

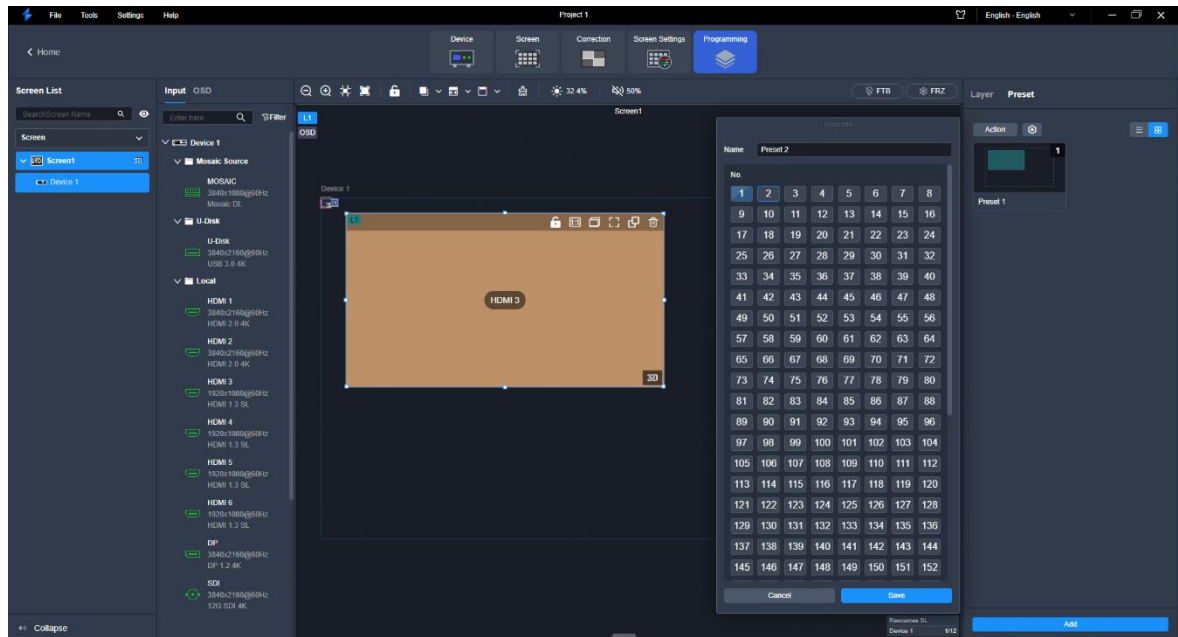

Step 3 In the preset number binding window, select the desired key number to save the current layer information to the preset.

One key number corresponds to one preset. The name of the save preset: Preset X ("X" refers to the bound key number.)

### Switch Display Style of Preset List

- ☰: List view

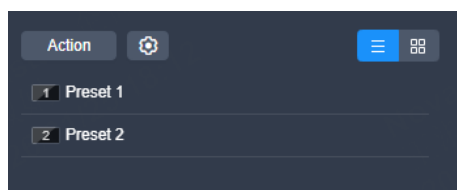

- ☐☐: Graphical view







### Load Presets





In the preset list, select the desired preset to load it.

After the preset is successfully loaded, the  icon will be displayed at the top left of the preview area.

## Rename Presets

- In the list view mode () , hover the mouse over the preset, and then click  . Enter a new name and then click elsewhere to make the change take effect.
- In the graphical view mode () , hover the mouse over the preview area, and then click  that appears. In the popup menu, select **Rename** and enter a new name, and then click elsewhere to make the change take effect.

## View Preset Details

- In the list view mode () , hover the mouse over the preset, and then click  that appears. In the popup window, you can view the name and screen of the preset.
- In the graphical view mode () , hover the mouse over the preview area, and then click  that appears. In the popup menu, select **Details** to show the popup window where you can view the name and screen of the preset.

## Set Preset Switching Effect

Click  , and then select the desired transition effect in the popup menu. The supported options are as follows.



- Cut: Switch one preset to another with no transition effect.
- Fade: Switch one preset to another with a fade effect.



After selecting **Fade** effect, click **OK** in the popup dialog box. Additionally, you can set the transition duration. The value ranges from 1s to 3s and it defaults to 2s.

### Note

- The fade effect takes effect on presets with less than 7x SL layers only.
- Only the VX2000 Pro supports setting of the preset switching effect.

## Delete Single Presets

- In the list view mode () , hover the mouse over the preset, and then click  that appears. In the popup window, select **Yes** to delete the preset.

- In the graphical view mode (  ), hover the mouse over the preview area, and then click  that appears. In the popup menu, select **Delete**, and then select **Yes** in the popup dialog box.

## Delete Multiple Presets

Click **Operation**, check the boxes next to the desired presets or check **Select All**, and click . In the pop-up dialog box, select **Yes**.

## 7.8 Tools

### 7.8.1 Maintenance

#### 7.8.1.1 Maintain Devices

In the menu bar, navigate to **Tools > Maintain**. Select the **Device** tab and the target devices, and then do the following as required.

Figure 7-40 Device maintenance (VX2000 Pro)

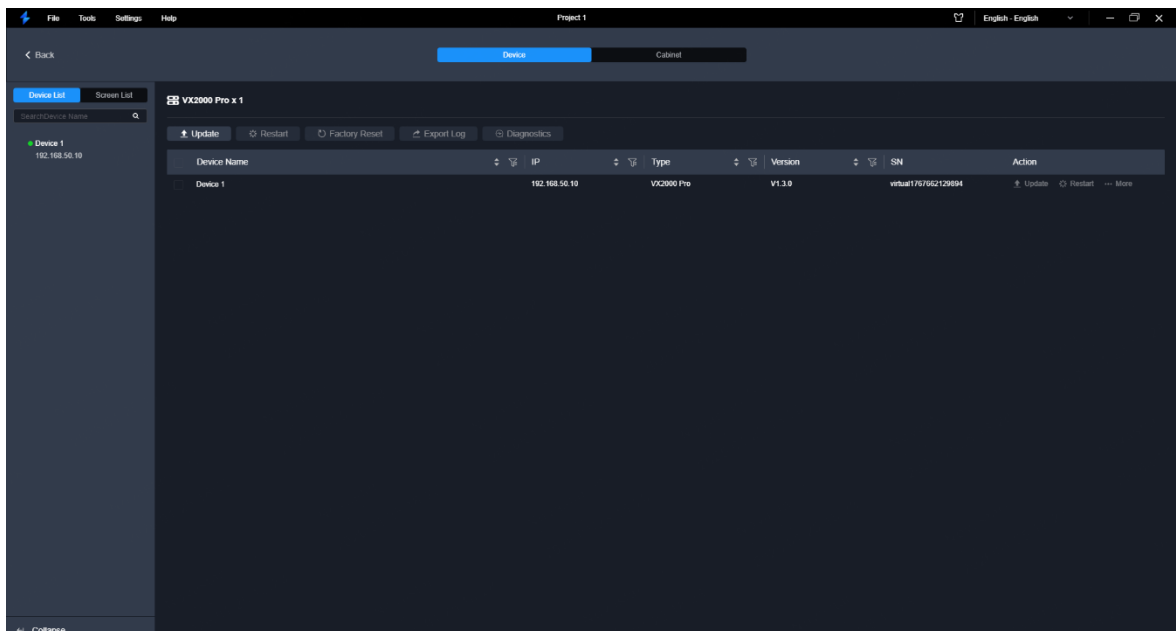

## Update



- During the update process, power-off and all operations are NOT allowed.

- Before updating the device, please connect the control PC and device using an Ethernet cable. USB connection is not allowed for update.
- 

Step 1 Click **Update**.

Step 2 In the pop-up dialog box, select the update file (.img) and click **OK**.

Step 3 Confirm the devices to be updated, and click the **Update** button.

Step 4 In the pop-up dialog box, click **Yes** and wait until the update completes.

Step 5 After the update completes, click **OK**.

## Restart

Click **Restart**. In the displayed dialog box, click **Yes** to restart the device.

## Factory Reset

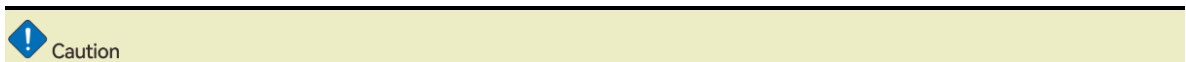

- Please do this with great caution.
  - The reset action does not affect the device firmware version.
  - Power-off is NOT allowed during the reset process.
  - The device will restart automatically after the reset is completed.
- 

Click **Factory Reset**. In the pop-up dialog box, select **Keep user data**, **Retain IP only** or **Reset all**, and then click **OK**.

- Retain user data

Retain the input EDID, imported files, language, device name, device IP, belonged project and restore points.

- Retain IP only

Only retain the device IP address and reset other parameters to factory defaults.

- Reset all

Reset all parameters.

Figure 7-41 Factory reset

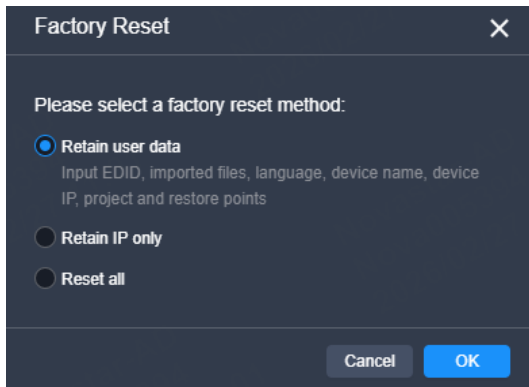

## Export Logs

Click **Export Log**. In the dialog box that appears, select a path and click **Save** to save the device logs to local computer.

## Device Diagnostics

Click **Diagnostics**. After the diagnostics completes, you can view the test result and take necessary measures as required.

Figure 7-42 Device diagnostics (VX2000 Pro)

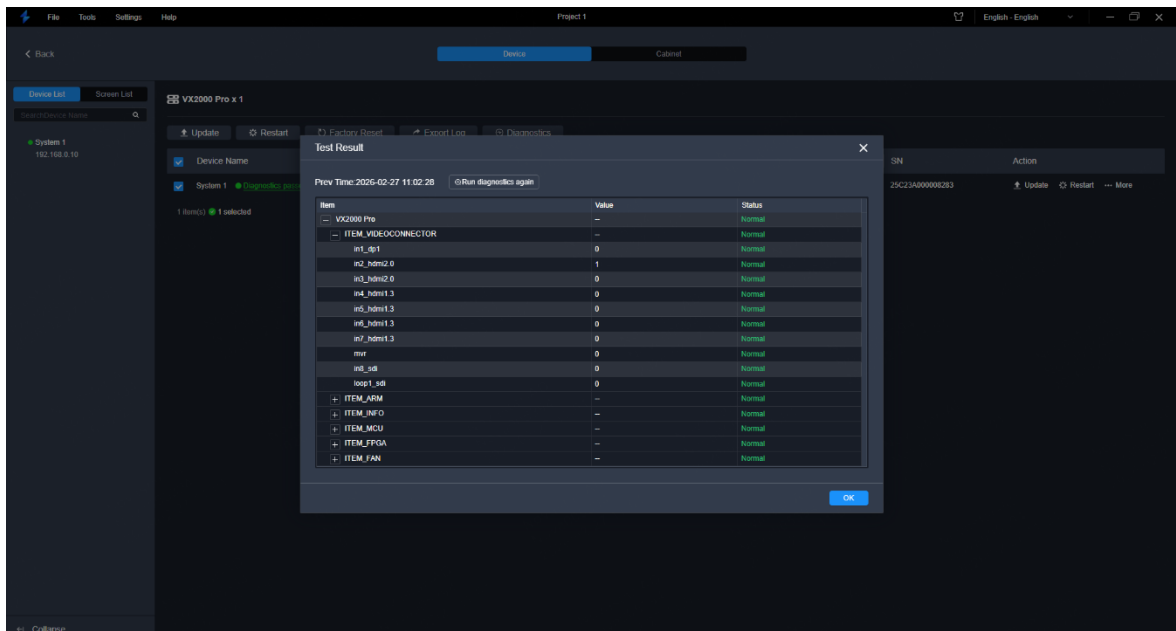

## 7.8.1.2 Maintain Cabinets

In the menu bar, navigate to **Tools > Maintain**. Select the **Cabinet** tab and the target cabinets, and then do the following as required.

Figure 7-43 Maintain cabinets

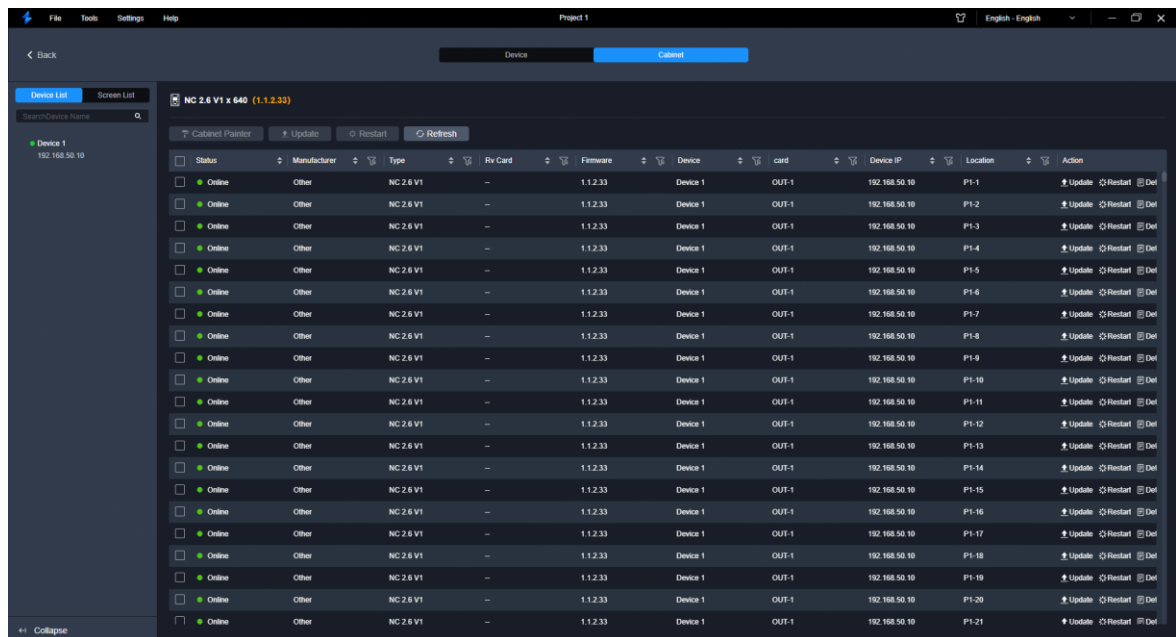

### View Cabinet Information

View the cabinet online status, cabinet manufacture, cabinet model, receiving card model, receiving card firmware, associated device, card (only applicable for card-based device), device IP and cabinet position.

### View Receiving Card Firmware

Click **Details** to view the FPGA and MCU versions of the receiving card.

### Cabinet Painter

Click **Painter** and select one or more cabinets so that other cabinets can have the same firmware program and configuration file as the selected cabinet.

### Update Cabinet Configuration Files

Select one or multiple cabinets, and then click **Update**.

Figure 7-44 Update cabinets

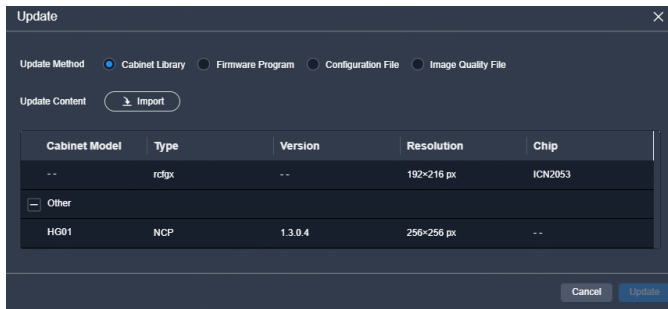

Select the desired update method in the popup window.

- Select an existing file: Choose an NCP/rcfgx file from the popup window and click **Update**.
- Import a new file: Click **Import** to upload an NCP/ file. You can select the import objects (multiple selections are possible) from **Local pack** or **Device pack**. Once the upload is complete, return to the **Update** interface, select the imported NCP/rcfgx file, and click **Update**.
- Firmware Program: Update the firmware version of the receiving card. Upload a file in image format, and then click **Update**.
- Configuration File: Update the cabinet configuration file. Upload an NCP/ rcfgx file, and then click **Update**.
- Image Quality File: Import the adjustment parameters of the image quality. Upload a file in vglcx format, and then click **Update**.

Note

The supported cabinet update method depends on the receiving card model.

## Restart Cabinet

Click **Restart**. In the popup dialog box, click **OK** to restart the cabinet.

## Refresh Cabinet Info

Click **Refresh** to refresh the cabinet information.

## 7.8.2 Configure Device Backup

Device backup allows you to set the backup relationship between two devices. You can set one of the devices as the primary device or the backup device. When the primary device has a

problem or the primary device's Ethernet cable fails, the backup device will take over the responsibilities of the primary device seamlessly and continue to work well to ensure the LED screen will not go black.

## Prerequisites

- Before creating a backup relation, make sure that both the primary and backup devices are on the same LAN.
- In a backup relation, the models and device versions of the primary and backup devices must be the same.

## Notes

- You have three options to create a backup relation: NovaLCT, Unico, or the device LCD menu. However, be aware that these methods do not synchronize with each other. Using more than one can lead to data problems. To prevent issues, choose only one method for setting up your backup. If you do mix them, you'll need to reset the device to factory settings and start over with just one method.
- In the device backup mode, the quantity of the cabinets loaded by each Ethernet port on both the primary and backup devices must be the same, but their data flow must be in a reversed way.

## Operation Procedure

Step 1 In the menu bar, go to **Settings > Device Backup**.

Step 2 In the pop-up window, click **Add** to add a backup relation.

Figure 7-45 Add backup relations (VX2000 Pro)

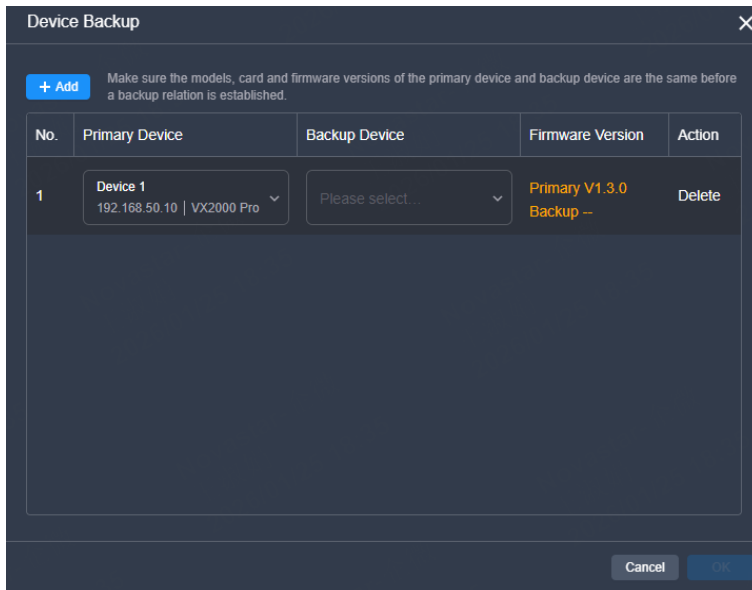

Step 3 Select the primary and backup devices from the drop-down lists respectively.

After the action completes, the firmware versions of the primary and backup devices will be displayed.

Step 4 Click **OK** to complete the backup relation settings.

Step 5 (Optional) Click **Delete** to delete the desired backup relation.

### 7.8.3 Manage Cabinet Library

In the menu bar, go to **Tools > Cabinet Library**. Do the followings as needed to manage the cabinet library files.

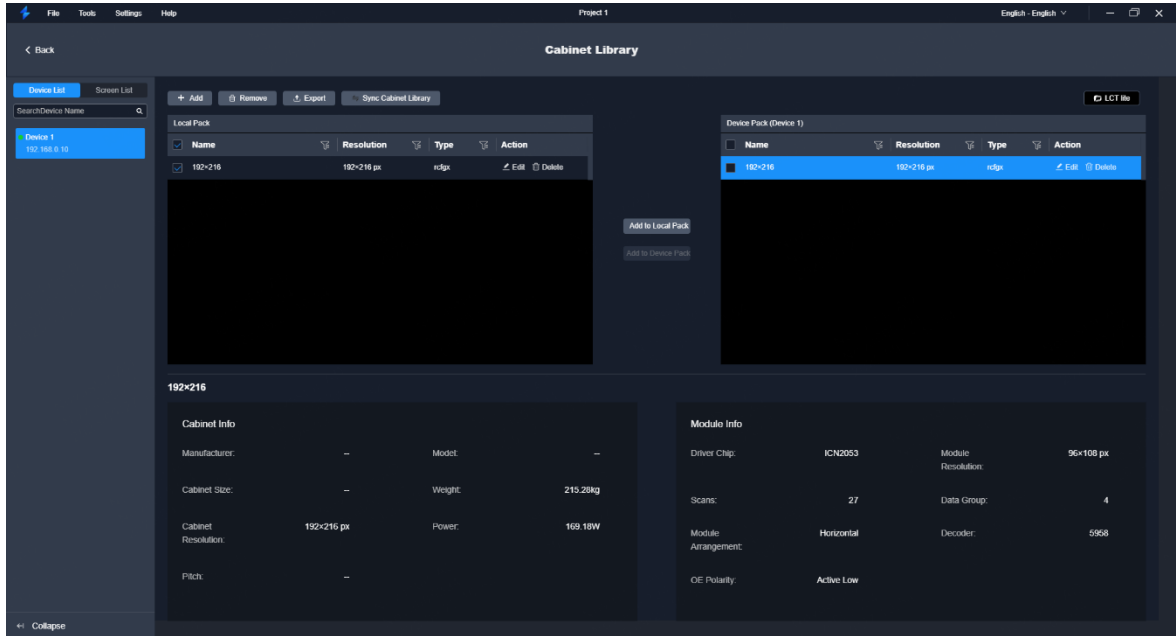

## Upload Cabinet Files

Step 1 Click **Add** and select the cabinet type in the displayed window.

The cabinet types are as follows.

- Cabinet File

Figure 7-46 Cabinet files

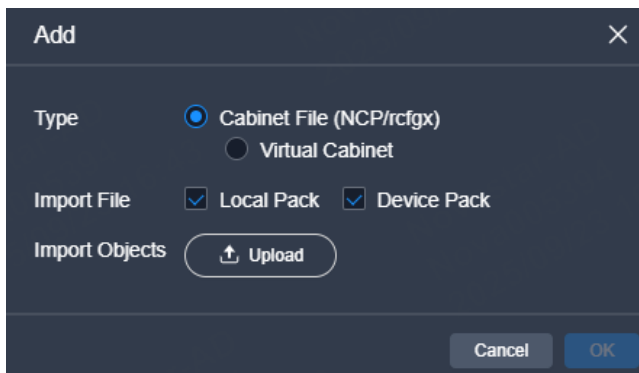

- Virtual Cabinet: If **Virtual Cabinet** is selected, you need to configure the parameters such as cabinet List name, resolution width and height.

Figure 7-47 Virtual cabinets

Step 2 Select the NCP/.rcfgx file to be imported from the local computer and click **Upload**.

After the file is selected, you can click **Delete** to delete the uploaded file.

## Export Cabinet Files

Step 1 Select one or more files on the **Cabinet Library** interface and then click **Export**.

For batch export, multiple files will be compressed as a .zip file and exported.

Step 2 Select a local directory and click **Save**.

## Sync Cabinet Files

- Sync cabinet files between devices
  - 1) Select the files to be synced (multiple files can be selected), and click **Sync Cabinet Library**.
  - 2) On the displayed window, select the devices to which the files are synced (multiple devices can be selected).

Figure 7-48 Sync cabinet files (VX2000 Pro)



3) Click **OK**.

## View Cabinet and Flash Info

Select a cabinet file, and the information about all the cabinets that use this cabinet file will be displayed.

Cabinet Info		Module Info	
Manufacturer:	—	Driver Chip:	ICN2053
Cabinet Size:	—	Scans:	27
Cabinet Resolution:	192x216 px	Module Arrangement:	Horizontal
Pitch:	—	OE Polarity:	Active Low
Model:	—	Module Resolution:	96x108 px
Weight:	215.28kg	Data Group:	4
Power:	169.18W	Decoder:	5958

## 7.8.4 Device Discovery

Add devices across different network segments or non-discoverable devices via IP addresses.

### Prerequisites

None

### Notes

None

## Interface Example

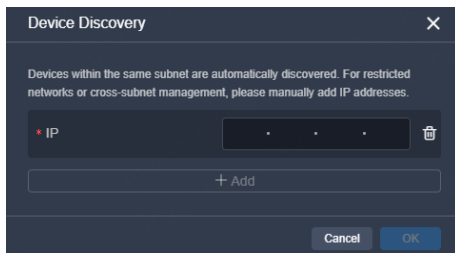

## Configuration

Navigate to **Tools > Device Discovery** from the menu bar. In the popup window, click **Add** to manually input the device IP. Once added, click **OK**.

## 7.8.5 Test Tool

Utilize test patterns to assess display performance and pinpoint issues.

### Prerequisites

For better software operation when the display window is large, it is recommended to prepare an extended display for viewing test patterns.

### Notes

The test tool only supports Windows operating systems.

## Interface Example

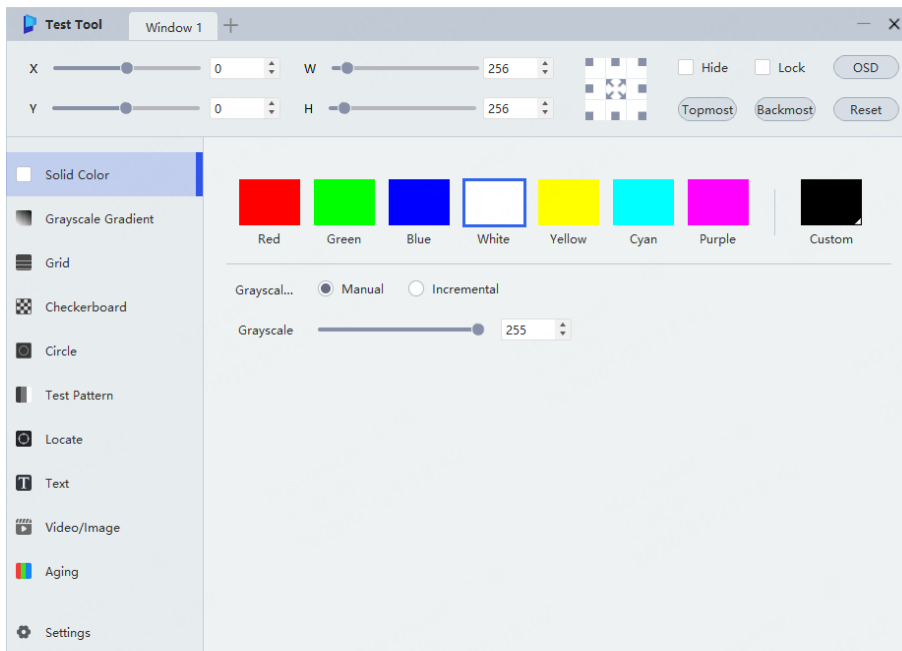

## Description

Navigate to **Tools > Test Tool** from the menu bar to open the test tool configuration interface. Please refer to the *Test Tools User Manual* for specific operations.

## 7.9 Software Settings

### 7.9.1 Switch UI Language

Select the desired language from the drop-down list at the top right corner to switch the UI language.

### 7.9.2 Change Skin

In the upper right corner of the interface, click  to select the desired skin.

Figure 7-49 Change skin



### 7.9.3 Export Logs

In the menu bar, navigate to **Settings > Export Log** to export the logs of the Unico software.

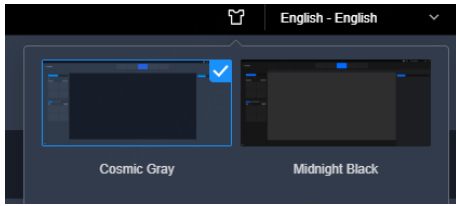
### 7.9.4 Configure Preferences

In the menu bar, navigate to **Settings > Preferences**. Turn on the desired features (checked "✓") or off (unchecked).

- Screen Resources: Show the layer resources on the **Programming** interface if enabled.
- Lock Aspect Ratio: Lock the aspect ratio when adjusting the width and height of new layers if enabled.

### 7.9.5 View Software Info

In the menu bar, go to **Help > About Us** to view the software-related info.

### 7.9.6 Check User Manual

In the menu bar, navigate to **Help > User Manual** to scan the QR code or click the link provided to access the latest product documentation.

# 8 Appendix

## 8.1 Loading Capacity Calculation Method in Low Latency Mode

In low latency mode, the effective loading capacity of a single Ethernet port will change according to the coordinates of the connected cabinets. This chapter introduces how to calculate the effective loading capacity of an Ethernet port in low latency mode.

### Calculation Formula

Max loading capacity of a single Ethernet port =  $(1 - (Y / H)) \times \text{TOTAL}$

- Y: The minimum Y coordinate of all cabinets loaded by a single Ethernet port
- H: The total height of the current canvas
- TOTAL: The maximum loading capacity of a single Ethernet port in common mode, fixed to 650,000.

### Calculation Example

As shown in the figure below, the minimum Y coordinate of the cabinets connected to an Ethernet port is 1200 (Y = 1200), the total height of the canvas is 2160 (H = 2160), and the max loading capacity is 650,000 (TOTAL = 650,000). Based on the calculation formula, the maximum loading capacity of this Ethernet port in low latency mode is:

$$(1 - (1200 / 2160)) \times 650,000 \approx 0.556 \times 650,000 \approx 361,400$$

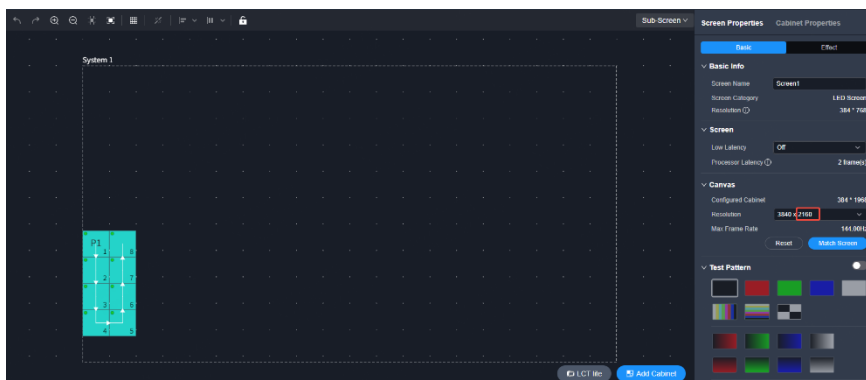

 Note

The loading capacity of the Ethernet port is only related to the minimum Y coordinate of the connected cabinets and has nothing to do with the X coordinate.

---

## 9 Copyright

**Copyright © 2026 Xi'an NovaStar Tech Co., Ltd. All Rights Reserved.**

No part of this document may be copied, reproduced, extracted or transmitted in any form or by any means without the prior written consent of Xi'an NovaStar Tech Co., Ltd.

### Trademark

 is a trademark of Xi'an NovaStar Tech Co., Ltd.

### Statement

Thank you for choosing NovaStar's product. This document is intended to help you understand and use the product. For accuracy and reliability, NovaStar may make improvements and/or changes to this document at any time and without notice. If you experience any problems in use or have any suggestions, please contact us via the contact information given in this document. We will do our best to solve any issues, as well as evaluate and implement any suggestions.

| [Official website](http://www.novastar.tech)  
| [www.novastar.tech](http://www.novastar.tech)

| [Technical support](mailto:support@novastar.tech)  
| [support@novastar.tech](mailto:support@novastar.tech)