

VX Pro Series

All-in-One Controllers

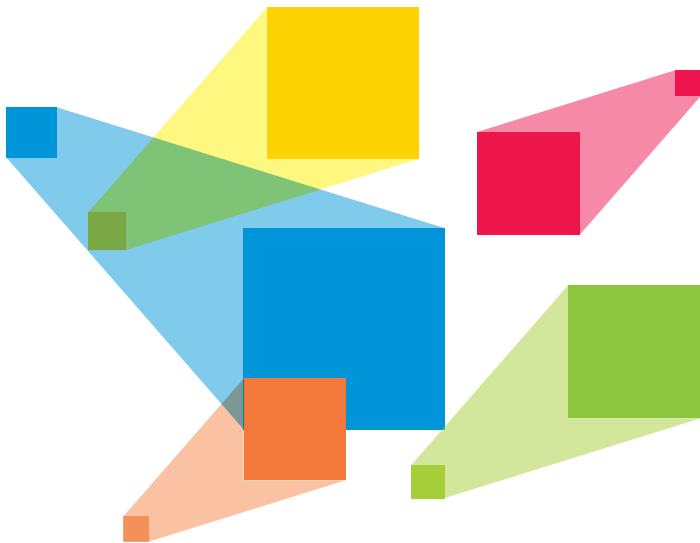

Quick Start Guide

1

Applications

The VX Pro series supports the following typical application scenarios. This guide uses the VX2000 Pro as an example to illustrate.

- Work as a video controller

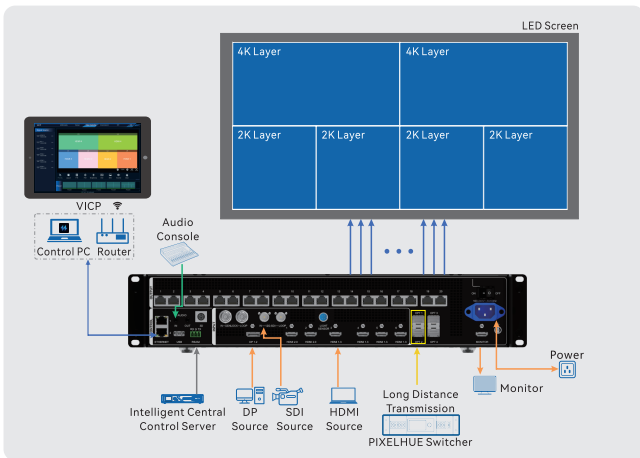

- Work as a fiber converter for long distance transmission

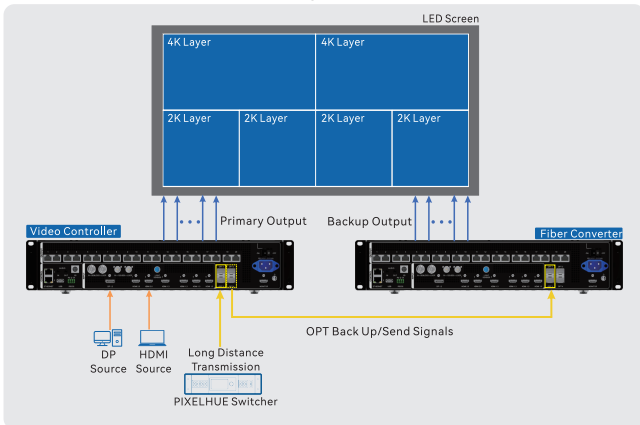

2

Screen Configuration

You can configure the screen via NovaLCT, Unico web page or device LCD menu. Select one of the methods without need for repeated configuration.

- **Via Unico Web Page**
Prerequisites

Connect the control PC to the device via an Ethernet cable or connect both of them to the same LAN.

Procedure

Step 1 Enter the device IP address into your browser 's address bar and press **Enter**. The web page appears. Select the desired device from the device list to enter the **Device** page.

Step 2 Click the **Screen** tab to enter the screen configuration page.

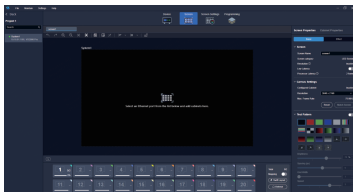

Step 3 Select the Ethernet port 1 from the bottom and then drag and click the mouse in the canvas area to add cabinets.

Step 4 Repeat **Step 3** to set the cabinets loaded by other Ethernet ports.

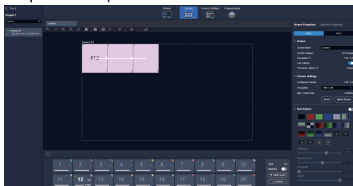

Notes

- The progress bar below the Ethernet port indicates the loading capacity usage of a single port. As shown in the above figure, these 3 cabinets have used 9.49% of the Ethernet port 12's capacity.
- You can modify the cabinet connection via the following two methods.
 - Click and drag a single cabinet.
 - Select all cabinets, and then select a quick topology in the cabinet properties area.

- Via LCD Menu

Prerequisites · LED screen must be a regular screen.

- Cabinets of the screen must be regular cabinets with the same resolution.
- The following data flow settings are supported. During data flow settings, ensure that the physical connection of each port is along the same direction and downward to next one.
- During data flow settings, ensure that Ethernet port 1 is at the beginning position of the whole physical connection.



Procedure

Step 1 Power on the VX2000 Pro and LED screen.

Step 2 On the home screen, press the knob to enter the main menu screen.

Step 3 Go to **Screen Configuration > Quick Configuration** to enter the quick configuration screen.

Step 4 Set **Cabinet Row Qty** and **Cabinet Column Qty** according to the actual row and column quantities of the cabinets.

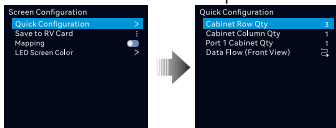

Step 5 Rotate the knob to select **Port 1 Cabinet Qty** to set the quantity of the cabinets loaded by Ethernet port 1.

Notes

- Cabinets loaded by Ethernet port 1 \geq cabinets loaded by Ethernet port 2 $\geq \dots \geq$ cabinets loaded by Ethernet port 20
- The quantity of cabinets loaded by each Ethernet port must be an integer multiple of **Cabinet Row Qty** or **Cabinet Column Qty** of the screen.

Step 6 Rotate the knob to select **Data Flow (Front View)** and press it, then select an appropriate physical connection for the cabinets.

During data flow settings, you can view the real-time effects of different data flow settings on LED screen by rotating the knob. When you are satisfied with the LED screen image, press the knob to save the settings.

3

Layer Operations

Add Layers

- Via LCD Menu Operations

Step 1 On the device front panel, locate and press the desired layer button in the **LAYER** area, and then the button becomes flashing and the device screen displays the layer settings screen. The layer will be opened automatically.

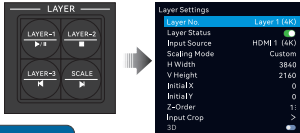

Notes

- In the layer list, both the current opened layers and the layers to be opened are displayed.
- Layer name displayed in the layer list: Opened layer: Layer n (capacity), unopened layer: Layer n, and "n" represents the layer number.

Step 2 Rotate the knob to select **Input Source** and press the knob to open the input sources pane. Select the desired input source for the layer and press the knob to confirm.

The layer parameters are illustrated as follows.



The greater the priority number is, the higher priority the layer has. In the above example, the priority of layer 2 is higher than that of layer 1.

Tip

You can also add a layer via menu operations. On the main menu screen, go to **Layer Settings > Layer No.** to display the layer list. Select the desired layer and toggle the switch next to **Layer Status** to open the layer.

• Via Unico Web Page

- Step 1 Click the **Programming** tab to enter the layer editing page. All the connected devices and input sources are displayed in the device list and input source list respectively on the left.
- Step 2 Click an input source in the **Input** area on the left and drag it to the editing area to add a layer.

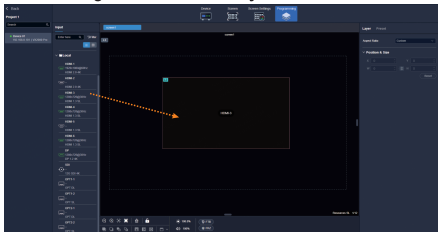

- Step 3 Click the added layer to select it, and then you can edit the layer name as well as adjust the layer aspect ratio, position and size.

» Notes

The VX2000 Pro supports 12*2K*1K layer resources. You can create layers in three specifications - 4K*2K, 4K*1K, 2K*1K. These layers will use 4x, 2x and 1x 2K layer resources respectively, depending on the capacity of the input connector used to open the layers.

Switch Layer Input Sources

You can switch the layer input sources via the following three ways.

- Via LCD menu
- Via front panel buttons
- Via Unico web page

- **Via LCD Menu**

On the main menu screen, go to **Layer Settings > Layer 1 (4K) > Input Source**, and then select the desired source and press the knob to confirm.

- **Via Front Panel Buttons**

Step 1 On the device front panel, locate and press the desired layer button in the **LAYER** area, and then the button becomes flashing and the device screen displays the layer settings screen.

Step 2 Press the desired input source button in the **SOURCE** area to switch the layer input source.

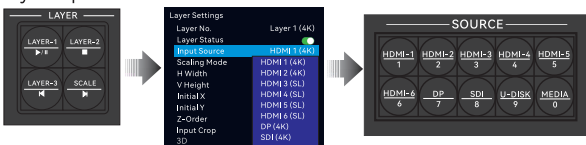

Notes

- If you do not select a specified layer, pressing the input source button switches the input source for the layer 1.
- Input connector capacity: 4K (4K×2K), DL (4K×1K), SL (2K×1K)

- **Via Unico Web Page**

Step 1 Select the desired input source in the **Input** area on the left.

Step 2 Click and drag the selected input source to an added layer to quickly switch the layer input.

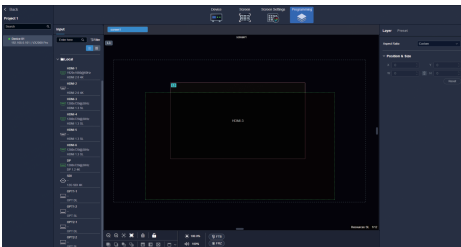

4

Preset Operations

The VX2000 Pro supports up to 256 user-defined presets. You can save the layer layout, input source and more as a preset for future use.

Save Presets

Prerequisites

You have completed the layer size, position and other settings.

Procedure

- Step 1 On the main menu screen, go to **Preset Settings** > **Preset 1** to open the preset operations window.
- Step 2 Rotate the knob to select **Save** and press the knob to confirm.

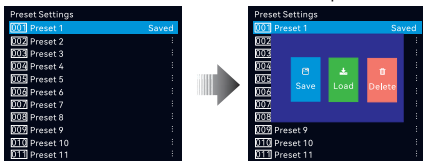

- **Save:** Save the current layer settings to a specified preset. If the target preset is a saved one, it will be overwritten.
- **Load:** Load and apply the selected preset to the LED screen.
- **Delete:** Delete the saved layer settings of the selected preset.

Load Presets

- Step 1 On the main menu screen, rotate the knob to select **Preset Settings** and press the knob to enter the preset settings screen.
- Step 2 Rotate the knob to select a saved preset and press the knob to open the preset operations window.
- Step 3 Select **Load** and press the knob to apply the preset to the screen.

Notes

Press the **PRESET** button on the front panel to quickly enter the preset setting screen.
You can press a number button to quickly load the corresponding preset.

5

Working Mode

You can set both the device working mode and OPT mode for the VX2000 Pro.

Device Working Mode

The VX2000 Pro supports three kinds of device working modes: **Video Controller** (Default), **Fiber Converter** and **ByPass**.

- **Video Controller:** The following three modes are supported.
 - Input+output: OPT 1/2 for video input, while OPT 3/4 copies or backs up the output on Ethernet ports
 - Input+loop+output: OPT 1 for video input, OPT 2 for loop output, while OPT 3/4 copies or backs up the output on Ethernet ports
 - Output: OPT 1/2 sends the output on Ethernet ports, while OPT 3/4 copies or backs up the output on Ethernet ports.
- **Fiber Converter:** OPT 1/2 sends the output on Ethernet ports, while OPT 3/4 copies or backs up the output on Ethernet ports.
- **ByPass:** The device is used as a sending card to realize pixel-to-pixel display and meanwhile reduce the latency.

OPT Mode

The VX2000 Pro supports two OPT modes: **Backup** (Default) and **Copy**.

- **Backup:** OPT 3 and OPT 4 back up the output on Ethernet ports 1 to 10 and Ethernet ports 11 to 20 respectively.
- **Copy:** OPT 3 and OPT 4 copy the output on Ethernet ports 1 to 10 and Ethernet ports 11 to 20 respectively.

Hardware Connections for Copy Mode

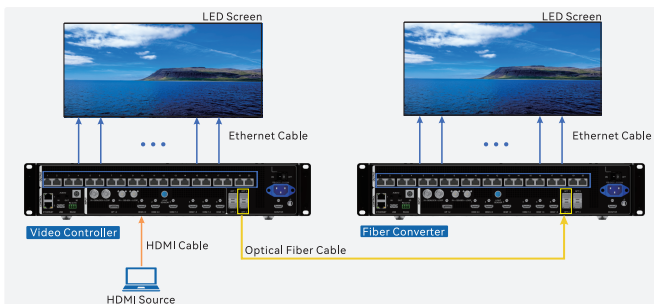

Hardware Connections for Backup Between Ethernet and OPT Ports

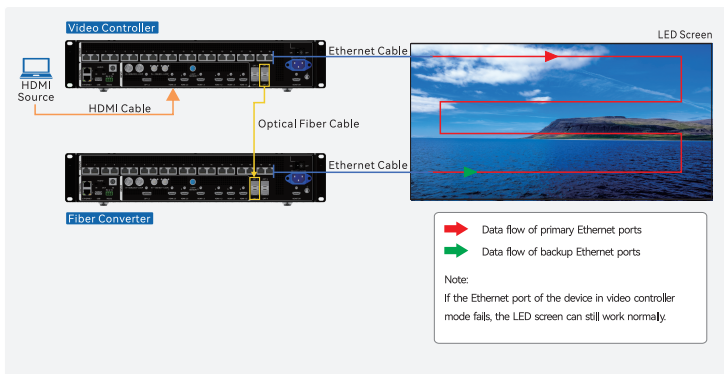

Hardware Connections for OPT Loop Mode

